



Aethalometer[®] Model AE33

User Manual

Version 1.54

March 2016

Aerosol d.o.o., Ljubljana, Slovenia



Aethalometer® Model AE33 Manual

Version 1.54, March 2016

Applicable for AE33-Software ver. 1.1.8.0

Copyright 2012-2016 Aerosol d.o.o. Magee Scientific Aethalometer® Manual. All Rights Reserved.

Licensed OEM distributors may use the contents of this manual with their own names, trademarks and logos for branding purposes for the distribution of Aethalometer® instruments, but may not modify the text without the prior written permission of Aerosol d.o.o., and must include the copyright notice in italics above on all copies.

Aerosol d.o.o.
Kamniška 41
SI-1000 Ljubljana
Slovenia, EU

tel: +386 1 4391 700

fax: +386 59 191 221

www.aerosol.eu

www.magescientific.com

TABLE OF CONTENTS

1. GENERAL INTRODUCTION	11
2. SAFETY NOTES AND LABELS	15
3. WARRANTY	21
4. PACKING LIST	25
5 INTRODUCTION.....	29
5.1 Basic calculations	30
5.2 Functional description of the instrument.....	32
5.3 Flow Diagram.....	38
6. IDENTIFICATION AND MARKINGS.....	41
6.1 Instrument identification label	41
6.2 Front panel markings.....	41
6.3 Back panel markings	42
7. INSTRUMENT INSTALLATION	45
7.1 Unpacking the system	45
7.2 Attaching the air sample inlet line.....	45
7.3 Switching the Aethalometer on	47
7.4 Installation of the instrument in a measurement station.....	49
8. USER INTERFACE, SETTINGS and OPERATION	55
8.1 User interface and settings	55
8.2 Instrument Status.....	62
9. MAINTENANCE	69
9.1 Cleaning The Optical Chamber	70
9.2 Replacement of the Filter Tape Roll	73
9.3 Manual flow calibration	76
9.4 Leakage test.....	79
9.5 Stability test.....	82
9.6 Clean Air test.....	84

9.7 Automatic Clean Air Test	86
9.8 Tape Sensor calibration.....	86
9.9 Flow verification	87
9.10 ND Optical Filter test	90
9.11 Inlet Leakage test	92
9.12 Lubrication of Optical Chamber Sliders	93
10. SERIAL DATA PORT CONNECTIONS.....	99
10.1 External devices	101
10.1.1 AMES_TPR159	102
10.1.2 Comet_T0310.....	102
10.1.3 Vaisala_GMP343	102
10.1.4 TSI_4100.....	102
10.1.5 Datalogger_AE33_protocol	102
10.1.6 Sample Stream Dryer	102
10.1.7 “Bayern Hessen” datalogger protocol	102
10.1.8 Datalogger Qair protocol.....	104
10.1.9 AE33_data streaming	106
10.2 Connecting to External Datalogger or PC.....	106
11. DATA MANAGEMENT	109
11.1 Exporting the Data	109
11.2 System restore	113
11.3 Basic settings.....	113
11.4 BC source apportionment.....	114
12. SOFTWARE UPGRADE	119
13. TROUBLESHOOTING.....	123
13.1 Startup screen checks	123
13.2 Instrument status	124
13.3 Unacceptable quality control test results.....	125
13.4 Other issues	125

14. SPECIFICATION	129
15. ACCESORIES.....	130
16. DRAWINGS	135
17. THEORY OF OPERATION.....	141
18. CONFORMITY DOCUMENTS.....	151
19. CUSTOMER SERVICE.....	155
20. RETURNS FOR SERVICE.....	156

CHAPTER
GENERAL INTRODUCTION

1. GENERAL INTRODUCTION



Figure 1. The Aethalometer® Model AE33.

Magee Scientific and Aerosol are pleased to present the 'Next Generation' Aethalometer®, Model AE33. This development incorporates scientific and technical advances which offer improved measurement performance, user features, communications and interface, and the ability to perform routine performance tests to verify correct operation. Most importantly, the instrument incorporates the patented DualSpot™ measurement method. This provides two significant advantages: elimination of the changes in response due to 'aerosol loading' effects; and a real-time calculation of the 'loading compensation' parameter, which offers insights into aerosol optical properties, and has been interpreted in models of aerosol origins and aging.

CHAPTER
SAFETY NOTES AND LABELS

2. SAFETY NOTES AND LABELS

CAUTION!

READ THIS CHAPTER VERY CAREFULLY BEFORE OPERATING THE INSTRUMENT.

Instrument operation

Read this User's Manual BEFORE operating the instrument.

INCORRECT instrument operation can be DANGEROUS for the operator.



Unauthorized instrument access and operation

The instrument must not be used in any manner which contravenes this Manual. Unauthorized internal access or incorrect operation can be dangerous. The instrument must only be operated by persons with suitable technical skills and practical experience, who can ensure its proper handling and use.



Electric shock

CHECK the A.C. mains power supply cord ANNUALLY. If the supply cable is DAMAGED or FRAYED, contact your authorized representative immediately for a replacement and do not use the instrument until the cord is replaced.

Fire and explosion



NEVER install the instrument in explosion-risk areas and never use the equipment near flammable substances.

Instrument overheating



ALWAYS provide adequate ventilation. NEVER install the instrument in spaces with limited air circulation.

UV radiation

The AE33 light source contains ultraviolet (UV) light emitting diodes (LEDs). These LEDs radiate UV and visible light during operation. Precautions must be taken to prevent looking directly at the UV light with unaided eyes. NEVER touch or look directly into the AE33 light source!

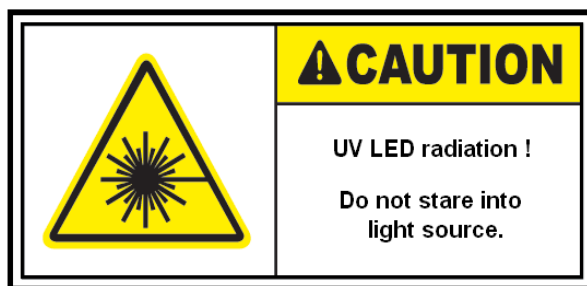

Instrument service and repair

UNAUTHORISED instrument service and repair procedures will VOID THE WARRANTY. The instrument can only be serviced by authorized persons. Please contact your authorized representative if you have any service questions or requirements



Moving parts

During AUTOMATIC tape advance procedure, the measurement chamber is lifted by a motorized lift mechanism. To prevent any injuries to your fingers, NEVER place your hands or fingers into ANY mechanical apertures, during automatic tape advance procedure.

During MANUAL chamber lift procedure ALWAYS use the chamber lift locking latch. To prevent any injuries to your hands or fingers, NEVER place your hands or fingers into ANY mechanical apertures. Exercise caution when lifting and releasing the chamber against its springs.

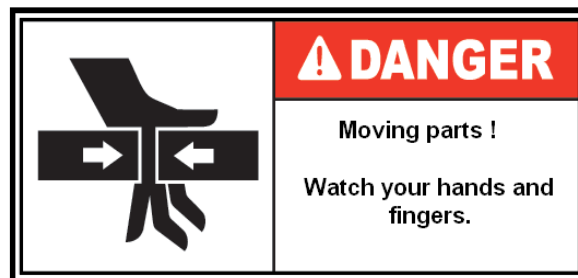

CHAPTER
WARRANTY

3. WARRANTY

Limited warranty statement: AETHALOMETER

Vers. 2016-01

Aerosol.do.o., (Seller), warrants that the Products will operate or perform in conformance with Seller's published specifications and be free from defects in material and workmanship, when subjected to normal, proper and intended usage by properly trained personnel, for the period of time set forth in the product documentation, published specifications or package inserts. If a period of time is not specified in Seller's product documentation, published specifications or package inserts, the Warranty Period shall be one (1) year from the date of shipment to Buyer for new equipment and ninety (90) days for all other products except consumables. Seller agrees during the Warranty Period, to repair or replace, at Seller's option, defective Products so as to cause the same to operate in conformance with said published specifications; provided that (a) Buyer shall promptly notify Seller in writing upon the discovery of any defect, which notice shall include the product model and serial number (if applicable) and details of the warranty claim; (b) after Seller's review, Seller will provide Buyer with service data and/or a Return Material Authorization ("RMA"); and (c) then, if applicable, Buyer may return the defective Products to Seller with all costs prepaid by Buyer. Replacement parts may be new or refurbished, at the election of Seller. All replaced parts shall become the property of Seller. Shipment to Buyer of repaired or replacement Products shall be made in accordance with the Delivery provisions of the Seller's Terms and Conditions of Sale. Consumables, including but not limited to filter tape, filters, and other such expendable items, are expressly excluded from the warranty. Notwithstanding the foregoing, Products supplied by Seller that are obtained by Seller from an original manufacturer or third party supplier are not warranted by Seller, but Seller agrees to assign to Buyer any warranty rights in such Product that Seller may have from the original manufacturer or third party supplier, to the extent such assignment is allowed by such original manufacturer or third party supplier.

In no event shall Seller have any obligation to make repairs, replacements or corrections required, in whole or in part, as the result of (i) normal wear and tear, (ii) accident, disaster or

event of force majeure, (iii) misuse, fault or negligence of or by Buyer, (iv) use of the Products in a manner for which they were not designed, (v) causes external to the Products such as, but not limited to, power failure or electrical power surges, (vi) improper storage and handling of the Products or (vii) use of the Products in combination with equipment or software not supplied by Seller. Specifically, this Warranty does not cover repairs of the Products that are required as the result of (viii) exposure to weather or rain, or the passage of water through the Product's air sampling and handling systems, (ix) exposure to excessive dust, (x) transportation in improper packaging and (xi) damage due to internal condensation of water, if the Product is sampling outdoor air with a very high humidity, and the Product is in a room with excessively cold air-conditioning with a temperature below the condensation point of the outdoor sample air, leading to condensing of water inside the Product.

If Seller determines that Products for which Buyer has requested warranty services are not covered by the warranty hereunder, Buyer shall pay or reimburse Seller for all costs of investigating and responding to such request at Seller's then prevailing time and materials rates. If Seller provides repair services or replacement parts that are not covered by the warranty provided in this warranty, Buyer shall pay Seller therefor at Seller's then prevailing time and materials rates.

ANY INSTALLATION, MAINTENANCE, REPAIR, SERVICE, RELOCATION OR ALTERATION TO OR OF, OR OTHER TAMPERING WITH, THE PRODUCTS PERFORMED BY ANY PERSON OR ENTITY OTHER THAN SELLER WITHOUT SELLER'S PRIOR WRITTEN APPROVAL, OR ANY USE OF REPLACEMENT PARTS NOT SUPPLIED BY SELLER, SHALL IMMEDIATELY VOID AND CANCEL ALL WARRANTIES WITH RESPECT TO THE AFFECTED PRODUCTS. THE OBLIGATIONS CREATED BY THIS WARRANTY STATEMENT TO REPAIR OR REPLACE A DEFECTIVE PRODUCT SHALL BE THE SOLE REMEDY OF BUYER IN THE EVENT OF A DEFECTIVE PRODUCT. EXCEPT AS EXPRESSLY PROVIDED IN THIS WARRANTY STATEMENT, SELLER DISCLAIMS ALL OTHER WARRANTIES, WHETHER EXPRESS OR IMPLIED, ORAL OR WRITTEN, WITH RESPECT TO THE PRODUCTS, INCLUDING WITHOUT LIMITATION ALL IMPLIED WARRANTIES OF MERCHANTABILITY OR FITNESS FOR ANY PARTICULAR PURPOSE. SELLER DOES NOT WARRANT THAT THE PRODUCTS ARE ERROR-FREE OR WILL ACCOMPLISH ANY PARTICULAR RESULT.

CHAPTER
PACKING LIST

4. PACKING LIST

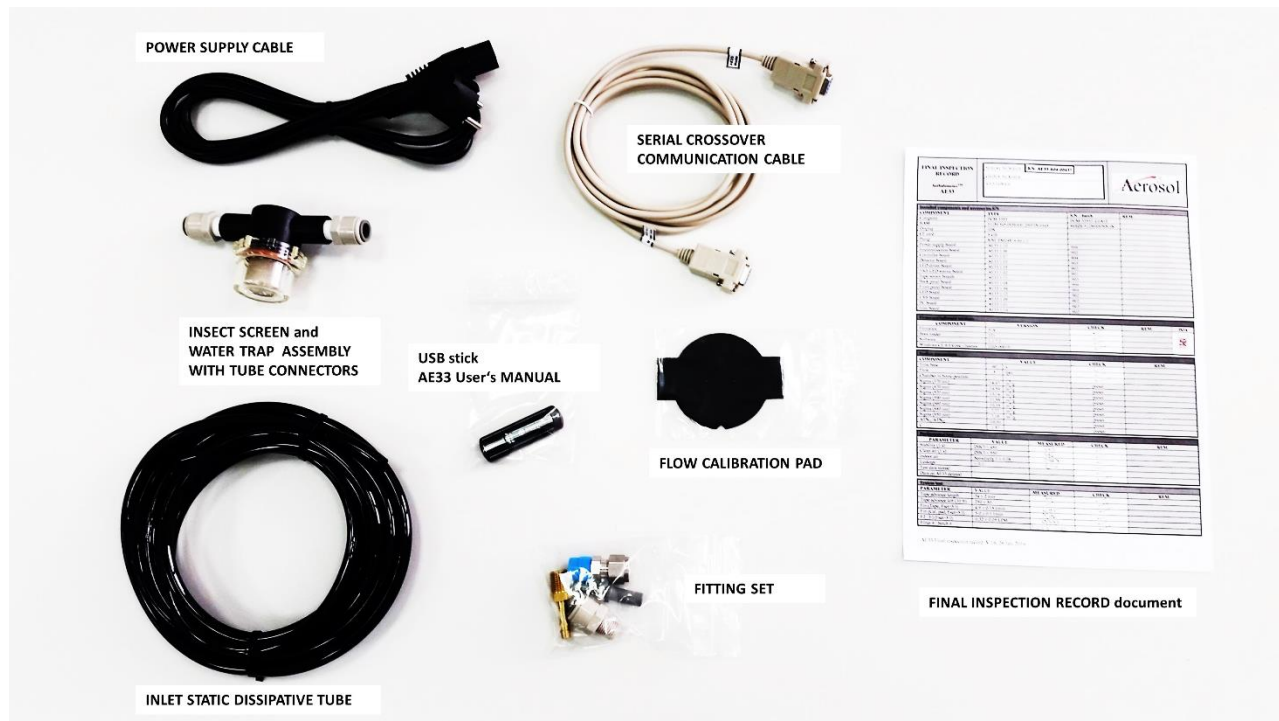

Standard Aethalometer AE33 accessories (packed with the instrument):

DESCRIPTION	PART NUMBER
3/8" OD Sample Inlet Tubing, static dissipative - 3 m	M4997
Fittings set	
Flow calibration pad	AE33 0 02 057
Final Inspection record	
Power supply cable (220/110 V)	AE33 1 99 011
Insect screen / water trap	M9556
USB stick with manual	
Packing sticker	
Null Modem Serial cable	B13M2943
Cartridge filter – bypass (already installed in the instrument)	M8072
Filter tape – 10 m roll (already installed in the instrument)	M8050

CHAPTER
INTRODUCTION

5 INTRODUCTION

The Aethalometer model AE33 collects aerosol particles continuously by drawing the aerosol-laden air stream through a spot on the filter tape. It analyzes the aerosol by measuring the transmission of light through one portion of the filter tape containing the sample, versus the transmission through an unloaded portion of the filter tape acting as a reference area. This analysis is done at seven optical wavelengths spanning the range from the near-infrared to the near-ultraviolet. The Aethalometer calculates the instantaneous concentration of optically-absorbing aerosols from the rate of change of the attenuation of light transmitted through the particle-laden filter. In the new Model AE33 Aethalometer, two measurements are obtained simultaneously from two sample spots with different rates of accumulation of the sample. Both spots derive their samples from the same input air stream. The two results are combined mathematically to eliminate nonlinearities and provide the compensated particle light absorption and BC mass concentration.

The method explicitly does not require any knowledge or assumption about the existence, origin or magnitude of any optical nonlinearity arising from the properties of the aerosol particles collected on the filter.

5.1 Basic calculations

The determination of the Black Carbon concentration is based on the measurement of light absorption on a filter loaded with aerosols:

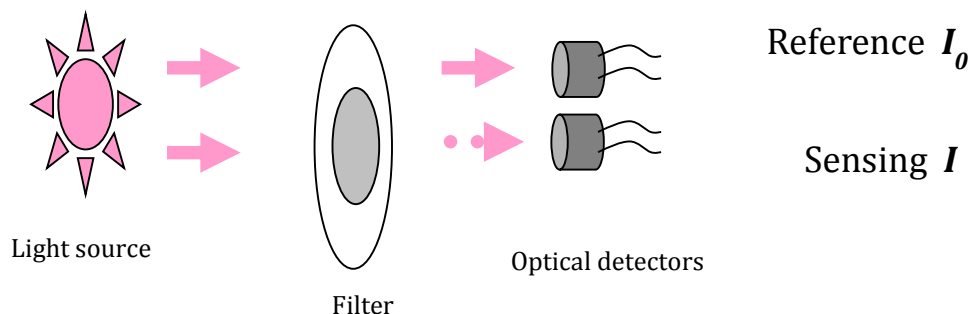

Optical attenuation:

$$ATN = -100 * \ln(I/I_0)$$

I_0 = reference signal;

I = spot signal

Flow:

$$F_{in} = F_{out} * (1 - \zeta)$$

F_{out} = measured flow

ζ = leakage factor

Attenuation coefficient:

$$b_{atn} = \frac{S * (\Delta ATN / 100)}{F_{in} \Delta t}$$

S = spot area; t = time

Absorption coefficient:

$$b_{abs} = \frac{b_{atn}}{C}$$

C = multiple scattering parameter

(Weingartner et al. 2003)

Black carbon concentration:

$$BC = \frac{b_{abs}}{\sigma_{air}}$$

σ_{air} = mass absorption cross-section

Loading effect compensation:

$$BC = BC_{measured} / (1 - k * ATN)$$

k = compensation parameter

Final equation:

$$BC = \frac{S * (\Delta ATN_1 / 100)}{F_1 (1 - \zeta) * \sigma_{air} * C * (1 - k * ATN_1) * \Delta t}$$

The optical absorption is measured at seven (7) wavelengths simultaneously.

The data obtained from channel 6 (measurement at 880 nm) is the defining standard used for reporting black carbon concentration:

Black carbon concentration: BC = BC6.

Data from the other channels are used for source apportionment. Their wavelengths and the Mass Absorption Cross-sections used in the calculations are as follows:

Channel	Measurement wavelength (nm)	Mass absorption cross-section σ_{air} (m²/g)
1	370	18.47
2	470	14.54
3	520	13.14
4	590	11.58
5	660	10.35
6	880	7.77
7	950	7.19

5.2 Functional description of the instrument

The AE33 is composed of several subsystems, interconnected in a modular way.

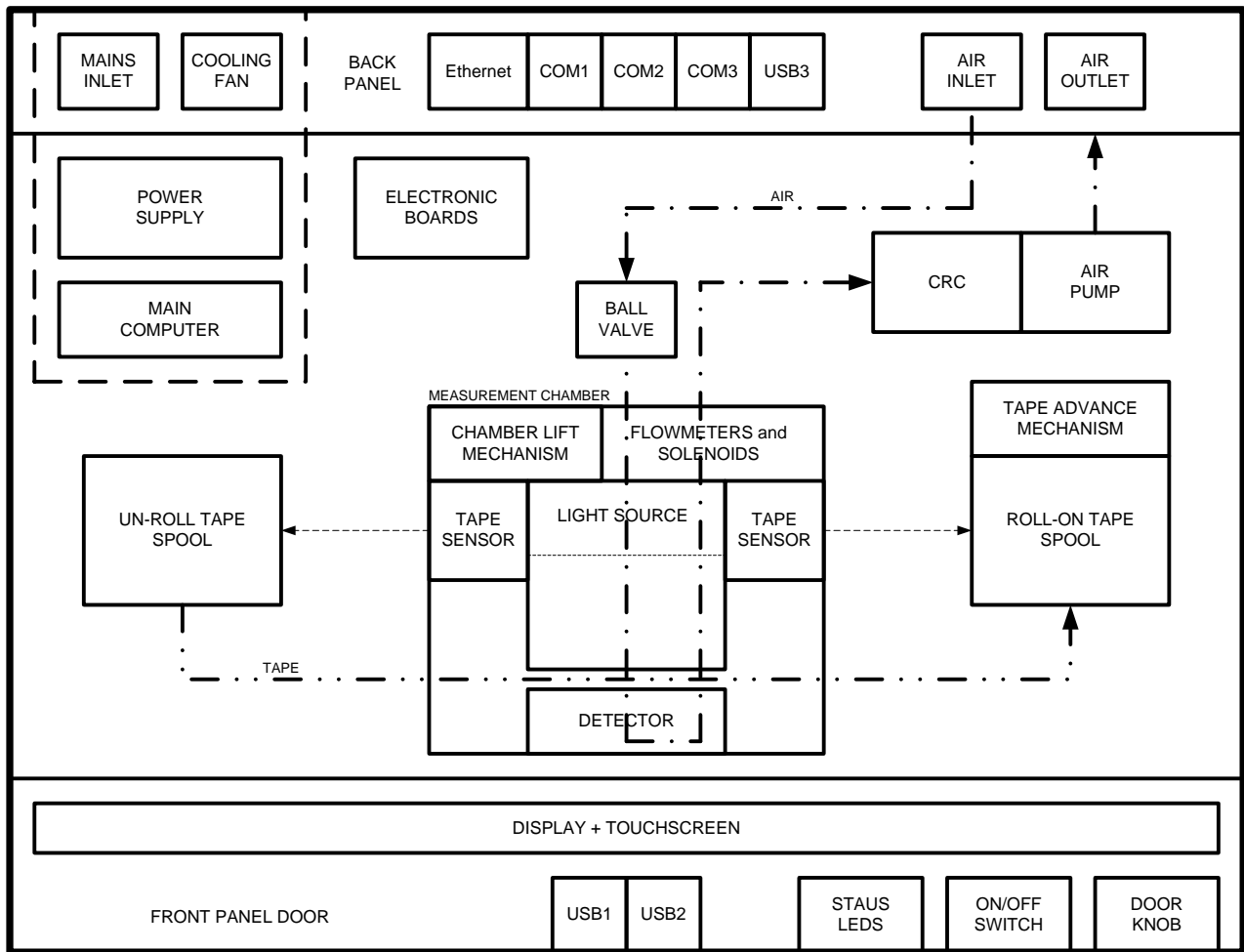

Figure 2. AE33 functional block diagram

ENCLOSURE

The AE33 enclosure is constructed of sheet steel for strength and durability under all conditions of field operations. The dimensions are for standard 19-inch rack mounting, with 6U chassis height.

POWER SUPPLY

The power supply module consists of the A.C. mains inlet, the power supply electronics and the cooling fan. Since this module dissipates some heat, it is constructed in a hermetically separated and thermally sealed area.

A.C. MAINS POWER INLET

The A.C. mains power inlet accepts standard EU, US or UK supply cords with the IEC-320 female connector end. It consists of the inlet itself, the EMC filter, the main fuse and the primary ON/OFF switch. The switch is a part of the power supply module.

COOLING FAN

The cooling fan is part of the power supply module. It is controlled thermostatically by electronics within the power supply area, and it switches on and off automatically during normal operation.

MAIN COMPUTER

The main computer board also dissipates some heat. Consequently, it is installed in the power supply area to take advantage of the ventilation. The high level software which controls the instrument and provides the user interface runs on this Windows-CE computer. This code is termed the Software ("SW"). Upgrades to the Software are published on the Users' Group website www.mageesci.com/group.

ELECTRONIC BOARDS

Each system module includes electronics boards providing local control functions with microprocessors. These use low-level code which is termed the Firmware ("FW"). Upgrades to the Firmware are published on the Users' Group website www.mageesci.com/group .

ETHERNET CONNECTOR

The Ethernet connector allows the connection of the AE33 measurement system to external networks.

COM1, COM2, COM3 CONNECTORS

The three COM-port connectors allow the connection of the system to RS232 based devices, such as external accessories and data loggers.

USB CONNECTOR

The USB connector allows the connection of the system to USB based devices, such as external accessories

SAMPLE AIR INLET and OUTLET CONNECTORS

The Sample Air Inlet fitting provides the connection of the instrument to the air stream to be analyzed. This may be outdoor or indoor ambient air; combustion effluents; or other laboratory equipment. The Outlet fitting is the discharge of the analyzed air stream from the instrument. This may be connected to trace gas analyzers (e.g. CO₂, offered as accessory); the Sample Stream Dryer (dehumidifier, offered as accessory); or returned to a manifold for flow balancing.

BALL VALVE

The ball valve is an electrically actuated valve with zero aerosol loss. It connects the analytical chamber either directly to the sampled air stream; or through a filter for the "active zero" noise test.

PULSE DAMPER

The pulse dumper (CRC) decreases pump pulsations in the internal airflow, which would otherwise perturb the very sensitive optical measurements.

DIAPHRAGM PUMP

The suction pump draws the sample air stream into the inlet connector and through the analytical filtration area. Its speed is under closed-loop software control to stabilize the sample flow rate to the desired flow set point.

FLOW SENSORS

Two flow-sensors measure the airflow in the two sampling streams. Their data is used in the BC calculation as well as for the closed-loop flow stabilization.

SOLENOID VALVES

Three solenoid valves are used to switch the airflow through different paths according to instrument operational settings.

CHAMBER SLIDES AND LIFT MECHANISM

The vertical slides (linear bearings) allow the measurement chamber to be lifted manually or electromechanically. When raised manually, a locking latch on the top of the chamber holds it in the raised position. A stepper motor and cam raise and lower the chamber under instrument control for automatic tape advance, or under manual control. A position sensor provides feedback to the software to confirm correct operation.

TAPE ADVANCE MECHANISM

The Tape Advance components allow the instrument to perform automatic tape advances during measurement operation. The primary components are a stepper motor on the “Collection” spool, and two tape sensors.

‘TAPE SUPPLY’ and ‘TAPE COLLECTION’ SPOOLS

The Filter Tape Roll is installed on the Supply (left-hand) spool and threaded through the Analysis Chamber area and onto the Collection (right-hand) spool. The Collection spool axis is turned by a motor to pull the tape forwards during the Tape Advance process. Optical sensors observe both tape rolls: data from the sensor observing the Tape Supply spool is used to estimate the quantity of tape remaining; and also to detect the ‘End-Of-Tape’ condition when the spool center is uncovered

TAPE SENSORS

Optical sensors on either side of the Measurement Head Bracket observe the tape spools and detect the amount of tape on each spool.

OPTICAL SOURCE

The Optical Source consists of arrays of LED chips of different emission wavelengths.

OPTICAL DETECTORS

The Optical Detectors quantitate precisely the amount of light passing through the two spots on the filter tape. Their data is digitized and passed to the Software to calculate the Black Carbon concentration in the sampled air stream.

FRONT PANEL DOOR

The front panel door provides access to the operational area for tape replacement or chamber cleaning. It is hermetically sealed to reduce contamination by dust.

DOOR KNOB

The push-pull knob secures the front panel door. Pull to open the door; push to latch it closed.

DISPLAY and TOUCH-SCREEN

The display and the touch-screen are the primary user interfaces of the instrument, and offer all functionality and operational control.

USB CONNECTORS

The two USB ports on the front panel door can be used to connect a keyboard, mouse, or solid-state memory drive for data download or upload.

STATUS LEDs

The red, yellow and green status LEDs provide an ‘instant glance’ of the operational status of the instrument. This status is replicated on the screen with the status flag (see Section 8).

POWER ON/OFF SWITCH

The front panel (secondary) POWER ON/OFF switch is located behind the front door. It is electrically connected in series with the primary ON/OFF switch, which is located on the rear panel of the instrument, next to the A.C. mains power inlet receptacle.

5.3 Flow Diagram

The Air Flow Schematic of the AE33 allows for different operational modes, per the table below. During normal sampling and analysis, sample air passes through Filter Spots S1 and S2 with different flow rates, defined by the orifice O2. The air flow rates through spot 1 (S1) and spot 2 (S2) are derived from the signals from Flow Sensors F1 and FC.

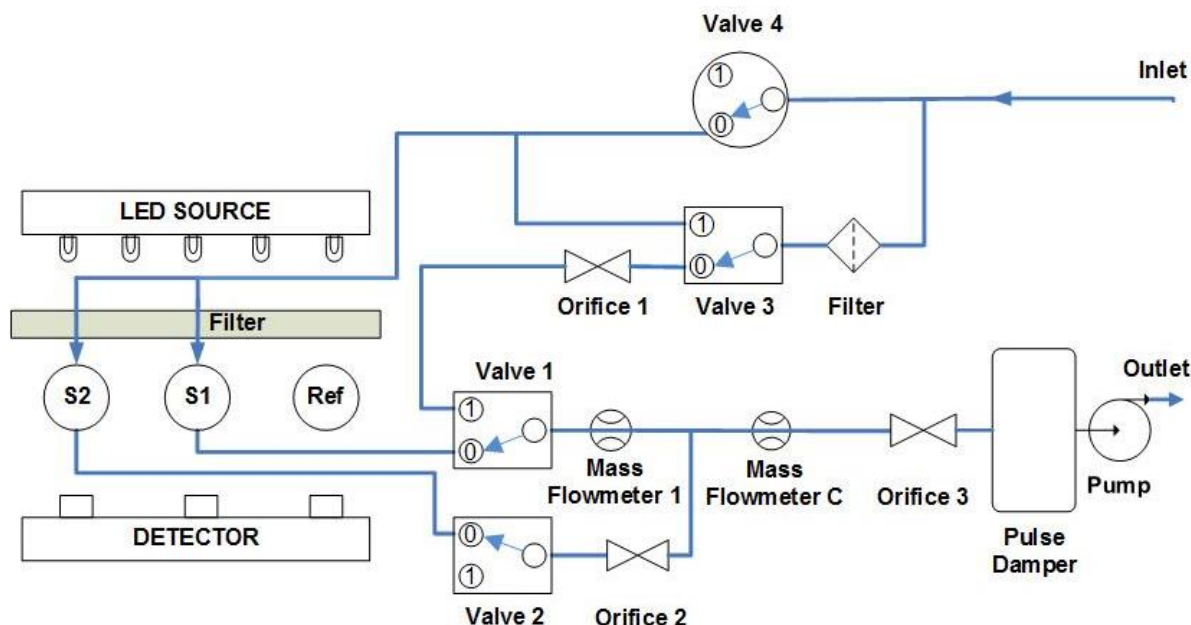

The code representing the Valve Status is formed from a series of binary values.

From highest to lowest binary values these are:

Valve 4-moving (1=YES / 0=NO), Valve 4 position (1=ON / 0=OFF),

Valve 3 position (1=ON / 0=OFF), Valve 2 position (1=ON / 0=OFF),

Valve 1 position (1=ON / 0=OFF)

Mode	Valve4	Valve3	Valve2	Valve1	Valve status
Bypass	1	0	1	1	01011
Warm-up/clean air	1	1	0	0	01100
Measurement	0	0	0	0	00000
Flowmeter calibration	0	0	1	0	00010

CHAPTER
IDENTIFICATION AND MARKINGS

6. IDENTIFICATION AND MARKINGS

6.1 Instrument identification label



6.2 Front panel markings

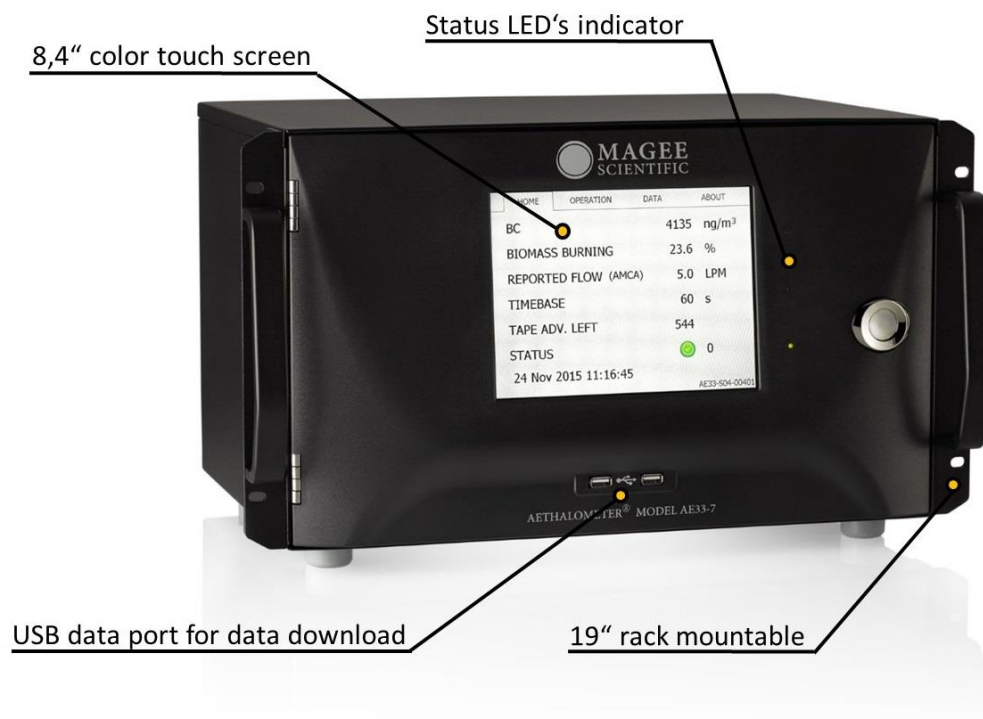

6.3 Back panel markings

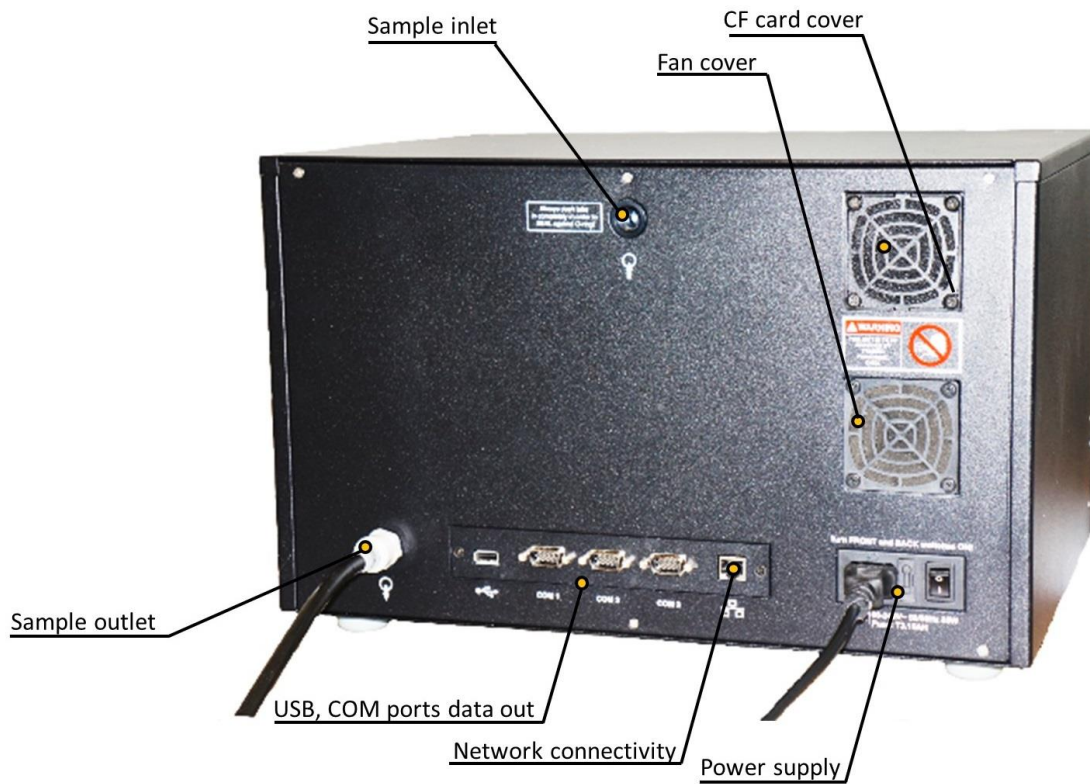

CHAPTER
INSTRUMENT INSTALLATION

7. INSTRUMENT INSTALLATION

7.1 Unpacking the system

Take the instrument out of the box and place it on an even surface. Keep the back of the instrument accessible.

Remember to remove the red protective caps on the inlet and exhaust ports before operation!



Figure 3. Remove the red protective caps on the rear panel of the instrument before switching it on!

7.2 Attaching the air sample inlet line

The instrument is supplied with several meters of special sample line tubing. This is made from static-dissipative polymers to minimize particle losses. Keep the sampling line as short as possible and do not substitute any material (other than metal tubing) for the special static-dissipative tubing. Be especially certain **to never use Teflon tubing** for any portion of the sample inlet line.

When installing the sample inlet line, avoid sharp bends. Insulate any sample inlet tubing from the cold discharge of an air-conditioner, as this can lead to condensation of humid air inside the

sample line tubing with subsequent damage to the instrument and serious effects on the validity of the measurement data.

The equipment package includes a selection of inlet fittings. According to your choice of inlet tubing, thread a suitable fitting into the Sample Inlet port on the rear panel of the Aethalometer (see Section 4, Fitting set). Use Teflon tape on the thread. If using the flexible static-dissipative tubing, insert the barbed connector into the black conductive tubing and then push it into the matching fitting on the rear panel of the instrument.

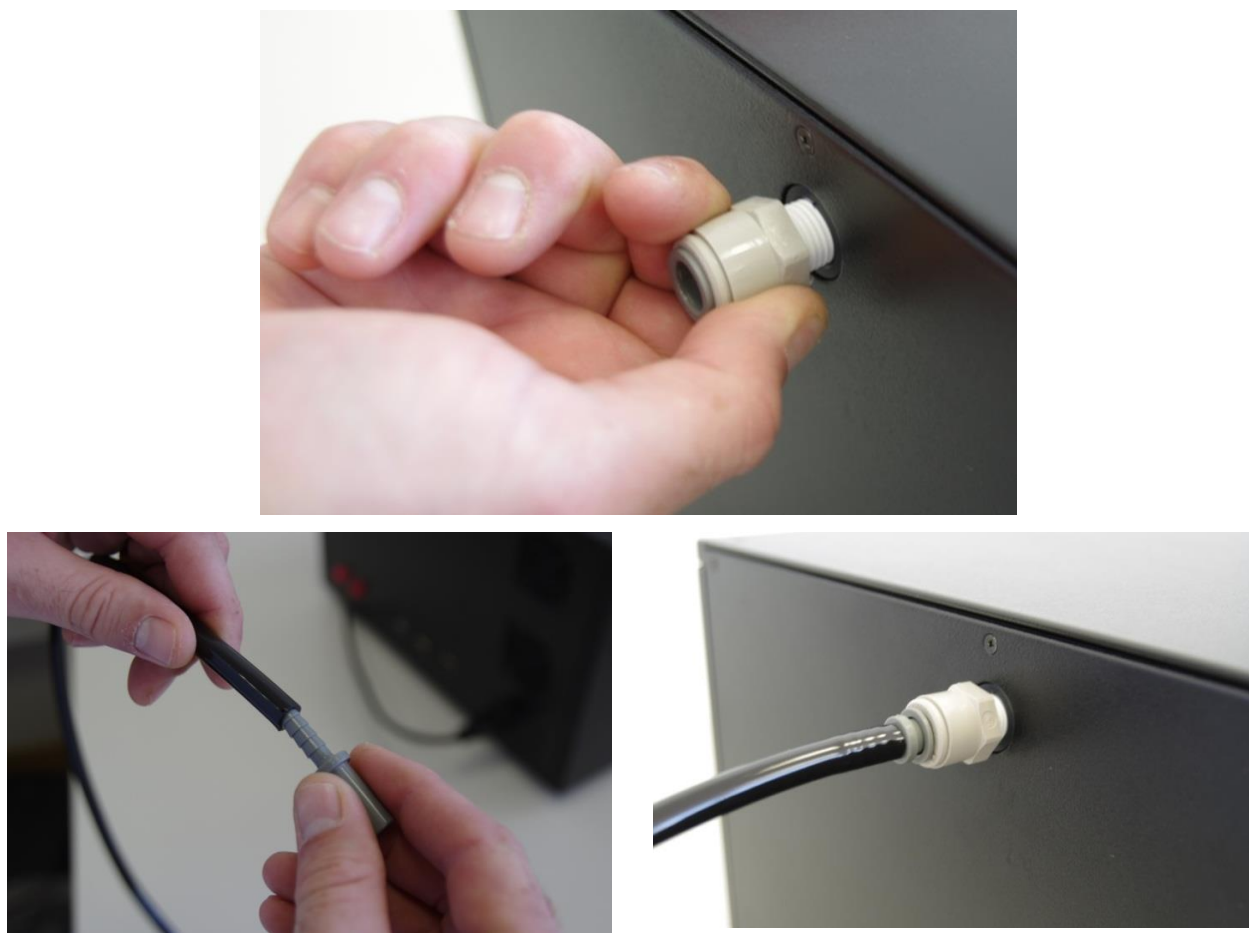

Figure 4. Fit the inlet connector on the rear panel of the Aethalometer and connect the sampling line tubing to it.

Install the insect screen and water trap assembly in the tubing at a location near the instrument so that it can be easily seen. Connect the other end of the sample line tubing to the

sampling manifold or to the inlet on the outside of the measurement station. Make sure that any openings in the station walls or ceiling are leak-proof.

MOST IMPORTANT: Always be sure to keep the end of the tubing inverted and sheltered so that rain-water cannot enter. The inlet should be unobstructed, securely fixed and placed at a distance of at least 0.5 meters from any roof or walls.

7.3 Switching the Aethalometer on

Connect instrument to AC power and turn the instrument on. There are two power switches – one on the rear panel and another on the front inside the door on the right.



Figure 5. Power on switches: rear panel and inside the door on the right.

Upon start-up, the instrument will perform electronic, optical and air-flow initialization test procedures which can take up to 5 minutes (see section 8.1 *User interface and settings*). All internal systems are tested, and the results are indicated by green check boxes for each step. The instrument will automatically begin measurements after the initialization tests finish.



Figure 6. The initialization screen with test results.

7.4 Installation of the instrument in a measurement station

a) The Aethalometer can be connected to a common sample air inlet manifold together with other instruments. Make sure that all other instruments draw constant flow and do not inject “reverse flow” into the manifold at any time. Make sure that the gauge pressure in the manifold is neither greater nor lesser than the ambient atmospheric pressure by more than 0.01 atm. The Aethalometer draws a constant air flow rate during all phases of measurement, tape advance and clean air tests.

b) The Aethalometer may draw from its own dedicated air sample inlet connection. This inlet **must be protected from rain**.

c) Size-selective inlets, such as PM1, PM2.5, and PM10 cyclones or impactors, may be used to exclude aerosol particles of large aerodynamic diameters.

d) The insect and water trap should always be installed in the sample inlet line, at a point close to the instrument and clearly visible. This will prevent the entry of contamination (which will compromise the data); or entry of water (either rain or condensation), which can lead to serious damage of the flow sensors.

e) If the indoor environment of the measurement station is air-conditioned, the inlet tubing lines should be insulated to avoid the condensation of water. If the sample stream dewpoint is high, we strongly recommend the use of our Sample Stream Dryer to remove water vapor from the sample air stream.



ATTENTION: Any water intake into the instrument can permanently damage the flow sensors. Damage due to water intake **is not covered by the warranty!**

f) Do not place the instrument in the direct outflow of an air-conditioner.

g) Clean the inlet cyclone and insect screen on a schedule of 1 to 3 months, depending on general concentration of air pollution and contaminants.

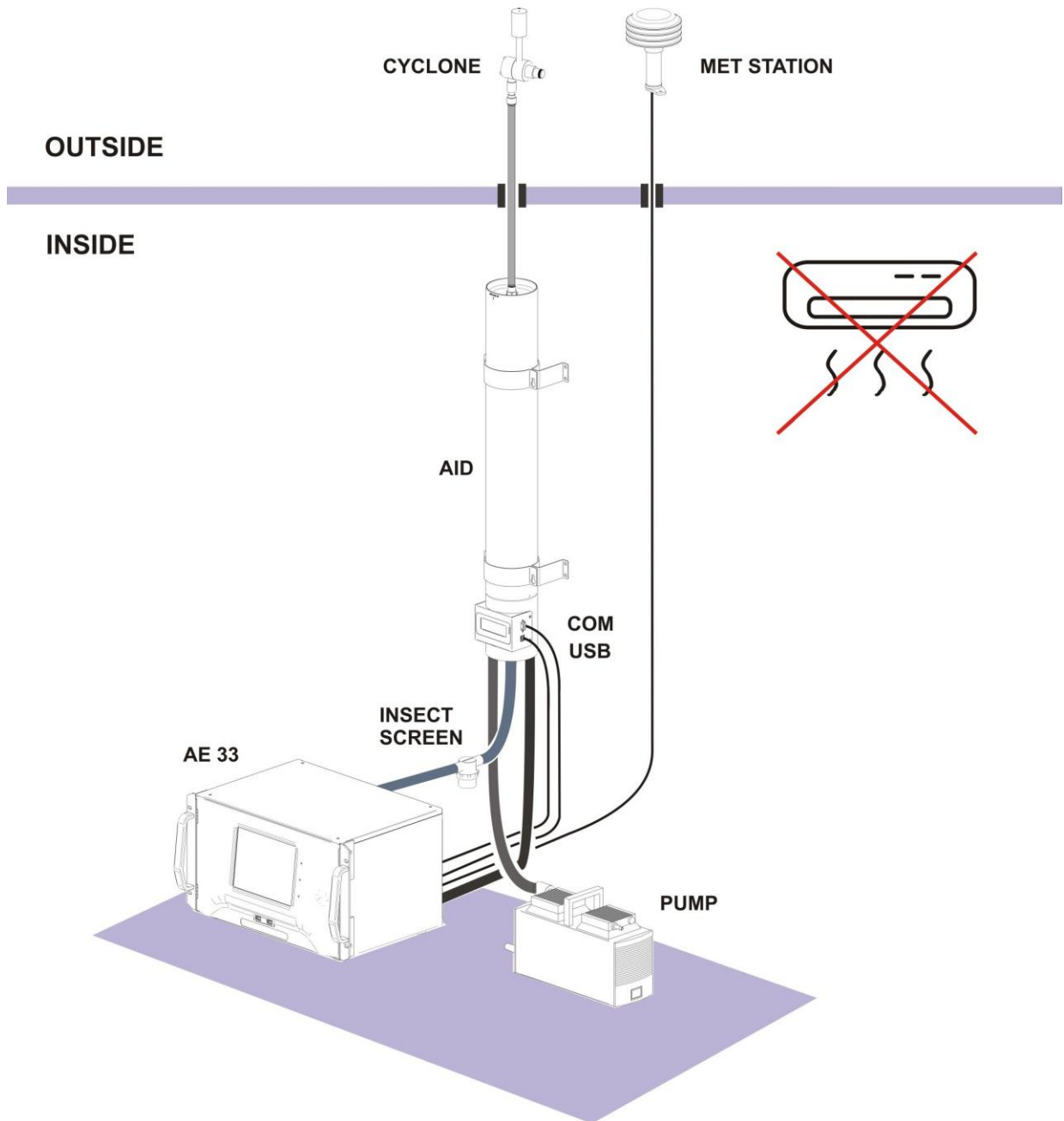

Installation using Sample Stream Dryer

CHAPTER
USER INTERFACE, SETTINGS AND OPERATION

8. USER INTERFACE, SETTINGS and OPERATION

8.1 User interface and settings

There are four top-level pages in the touch-screen user interface:

- **HOME PAGE** showing:
 - the measured values for Black Carbon (*measured at 880 nm, BC, Ch6*) and UV particulate matter (*measured at 370 nm, UVPM, Ch1*),

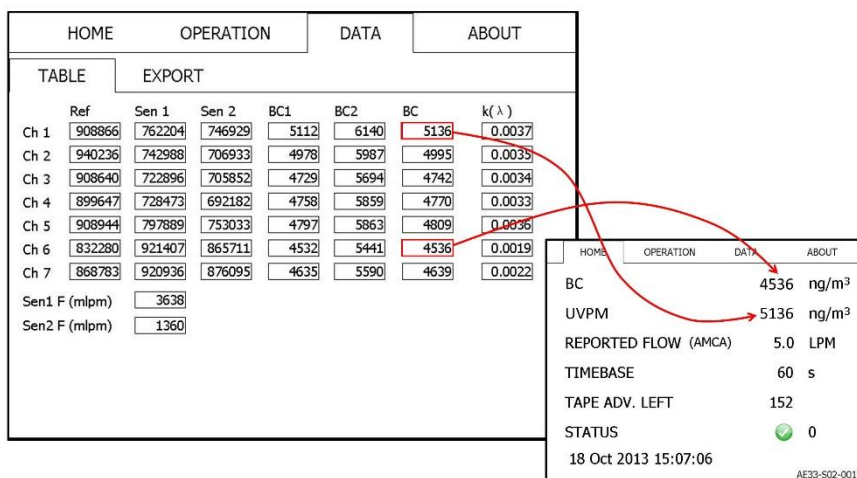

HOME		OPERATION		DATA		ABOUT	
TABLE		EXPORT					
Ref	Sen 1	Sen 2	BC1	BC2	BC	k(λ)	
Ch 1	908866	762204	746929	5112	6140	5136	0.0037
Ch 2	940236	742968	706933	4978	5987	4995	0.0035
Ch 3	908640	722896	705852	4729	5694	4742	0.0034
Ch 4	899647	728473	692182	4758	5859	4770	0.0033
Ch 5	908944	797889	753033	4797	5863	4809	0.0036
Ch 6	832280	921407	865711	4532	5441	4536	0.0019
Ch 7	868783	920936	876095	4635	5590	4639	0.0022
Sen1 F (mlpm)	3638						
Sen2 F (mlpm)	1360						

HOME		OPERATION		DATA		ABOUT	
BC			4536		ng/m ³		
UVPM			5136		ng/m ³		
REPORTED FLOW (AMCA)	5.0		LPM				
TIMEBASE	60		s				
TAPE ADV. LEFT	152						
STATUS	0						
18 Oct 2013 15:07:06							
AE33-S02-00138							

- measured flow,
- timebase setting,
- tape adv. left (the amount of remaining tape),
- status: green (all OK), yellow (check status), and red (stopped) with a status flag (see section 8.2 *Instrument Status*). Interpretation of the Instrument Status Code is shown by pressing the colored circular icon on the Home screen.
- date and time, instrument Serial Number.

Note: The BC and UVPM values will typically be similar, but not exactly the same. If aromatic compounds are present in the sampled air (such as when sampling fresh wood-smoke, for example), the UVPM concentration will exceed the BC mass concentration value significantly, depending upon the amount and type of organic material present.

- **OPERATION SCREEN** with four sub-tabs: GENERAL; ADVANCED; LOG; and MANUAL.

The **GENERAL** screen shows the settings:

HOME	OPERATION	DATA	ABOUT
GENERAL	ADVANCED	LOG	MANUAL
TimeBase	60 s	Start	Stop
Flow	2 LPM	Stability	Clean air
Flow Rep. Std.	AMCA	Verify flow	ND test
	P: 101325 Pa T: 21.11 °C	Leakage test	Inlet leakage
● TA ATNmax	120		
○ TA INT	12 h		
○ TA Time	01 Jan 2015 00:00:00		
Time & Date	03 Mar 2016 12:45:34		
Time zone	(GMT) Coordinated Universal Time		
<input checked="" type="checkbox"/> Auto Clean Air	<input checked="" type="radio"/> Weekly <input type="radio"/> Monthly	<input type="checkbox"/> DST	Shut down
	MON 11:15:00		

- timebase (seconds),
- flow (LPM),
- flow-reporting standard: These are the pressure and temperature which the instrument uses to report flow, based on the mass flow measured by the flow sensors. A variety of reporting standards are offered: choose the one used by your organization. Alternately, data may be calculated and reported at ambient conditions of T and P. These may either be input manually; or provided by the optional Meteorological Sensor, connected to one of the COM ports (*see chapter 10.1 External devices*).
- maximum attenuation which triggers a Tape Advance – TA_ATNmax or,
- the time interval (in hours) at which the Tape Advances will occur – TA_INT or,
- a single fixed time at which a Tape Advance will occur – TA_Time.
- Time & Date: adjusts current local time.
- Time zone and DST: Set to match your locality. If enabled, the ‘DST’ setting will automatically adjust for Daylight Saving Time.

The **ADVANCED** screen shows all the parameters used internally:

HOME		OPERATION		DATA		ABOUT	
GENERAL		ADVANCED		LOG		MANUAL	
Status	3	Flow Σ (mlpm)	0	Sigma_Air (Λ)	LED err	Detector err	
Controller status	0	Flow1 (mlpm)	3461	Ch1	18.47	0	0
Detector status	20	Pump (ref.val.)	0	Ch2	14.54	0	0
LED status	10	Flow sensor Σ	188	Ch3	13.14	0	0
TA status	0	Flow sensor 1	220	Ch4	11.58	0	0
Tape sensor left	127	Chamber status	10	Ch5	10.35	0	0
Tape sensor right	195	Chamber position	337	Ch6	7.77	0	0
TapeAdvance left	36	Valve status	00000	Ch7	7.19	0	0
ATNf1	10	Z	0.07	Kmax	0.015	Aff	1
ATNf2	30	C	1.57	Kmin	-0.005	Abb	2
Warm up interval (min)	3	TA adjust (%)	5	Date format	<input type="checkbox"/> US	<input checked="" type="checkbox"/> EU	
Firmware version	518			Measure time stamp	<input type="checkbox"/> Before	<input checked="" type="checkbox"/> After	
Software version	1.1.7.7			Home display	<input checked="" type="checkbox"/> UVPM	<input type="checkbox"/> Proc BB	
IP address	127.0.0.1			Display	<input type="checkbox"/> ON	<input checked="" type="checkbox"/> Saver	<input type="checkbox"/> Auto OFF
Server IP address							
<input type="checkbox"/> AutoConnect							
External ID	1	BH param ID	1	FlowCal	TapeSenAdj	LED adjust	
Serial number	AE33-S04-00411			Change Tape	External device	Update	

- ATNf1 – low point of compensation algorithm
- ATNf2 – high point of compensation algorithm
- Z – compensation algorithm parameter (tape tangential leakage)
- C – compensation algorithm parameter (optical enhancement factor)
- Kmax – maximum value of the compensation coefficient
- Kmin – minimum value of the compensation coefficient
- Aff – Ångström exponents for fossil fuel
- Abb – Ångström exponents for wood burning
- Warmup interval – duration of clean air initialization after tape advance
- TA adjust – fine adjustment of tape advance length (- 50 to 50 %)
- External ID – remote protocols instrument identification number (1 – 255)
- Measure time stamp – data line identified by the beginning or end of the measurement
- Home display – presents UVPM (Ch1) in ng/m³ or BB in %
- Display (Screen saver settings)
 - ON:** Screen is always switched on and displays live data
 - Saver:** After 60 minutes, the screen changes to a color-coded status indicator.
 - Auto OFF:** After 60 minutes, the screen switches off. Operational status is shown by LEDs on the right side of the screen.
 - The “Live” screen display is recovered by pressing the screen anywhere.
- IP address, Server IP address – settings only used with networking
- External ID, BH param – settings relevant to Bayern-Hessen protocol

The **LOG** screen shows the last operational reports of status, parameter changes, data downloads, and all instrument operations.

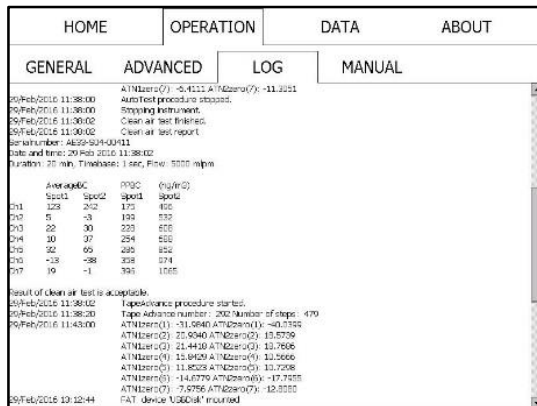

The **MANUAL** screen shows basic commands which can directly operate the various hardware elements (solenoids, pump, chamber, Tape Advance, etc.)

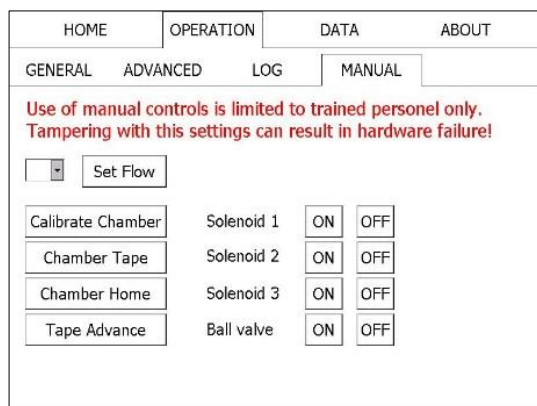

NOTE! – do not activate these manual functions without training!
Instrument damage may occur.

- The **DATA** screen has two sub-tabs: TABLE; and EXPORT.

The **TABLE** screen shows raw measurement values, BC concentrations calculated from each individual spot (BC1 = calculation from spot 1, BC2 = calculation from spot 2); and the compensated BC concentration derived by combination of the two individual spot results. All three concentrations are reported in units of ng/m³.

HOME		OPERATION		DATA	ABOUT		
TABLE		EXPORT					
	Ref	Sen 1	Sen 2	BC1	BC2	BC	k(λ)
Ch 1	480850	915921	950089	1768	2314	1768	0.0001
Ch 2	696857	877227	901013	1369	1912	1369	0.0001
Ch 3	682645	885690	903991	1154	2174	1154	0.0001
Ch 4	704607	864144	901588	1287	1946	1287	0.0001
Ch 5	720213	871726	906991	1117	1391	1117	0.0001
Ch 6	642403	860291	905895	552	-181	552	0.0001
Ch 7	688483	860055	904793	2266	3142	2266	0.0001
Sen1 F (mlpm)		3791					
Sen2 F (mlpm)		1492					

The **EXPORT** screen allows the selection of data to be copied to a USB memory drive.

- Export to USB –for the selected time periods, export data to a USB memory drive inserted into either of the front panel connectors. Data downloads may be performed **during normal instrument operation without interruption**.
- Delete data – deletes selected data. Be sure to back-up the data before deleting.
- Delete oldest if full – instrument automatically deletes oldest data and log files to keep minimum free space for normal instrument operation.
- System Restore allows for restoration of a previous operational setup file with all instrument parameter settings. Each saved setup file is identified by date and time coded in the file name (for more details please check section 11.2).
- Basic Settings allows the import of pre-set parameter settings from a USB stick (for more details please check section 11.3).

HOME	OPERATION	DATA	ABOUT
TABLE	EXPORT		
Free space: 20 year(s) and 152 day(s) left			
<input checked="" type="checkbox"/> Delete Oldest If Full			Delete data
From:	07 Jun 2015	To:	20 Mar 2016
			Sys restore
ExportToUSB			Basic settings

The **ABOUT** screen shows [instrument registration](#) and [user registration](#) details.

Instrument Registration – In order to receive latest updates, notifications about new features and functionalities, access to all technical materials (spec sheets, technical papers, video tutorials) and other resources, we encourage all users to complete the registration form at <http://www.mageesci.com/register>

The Users Group site offers interactive resources at www.mageesci.com/group.

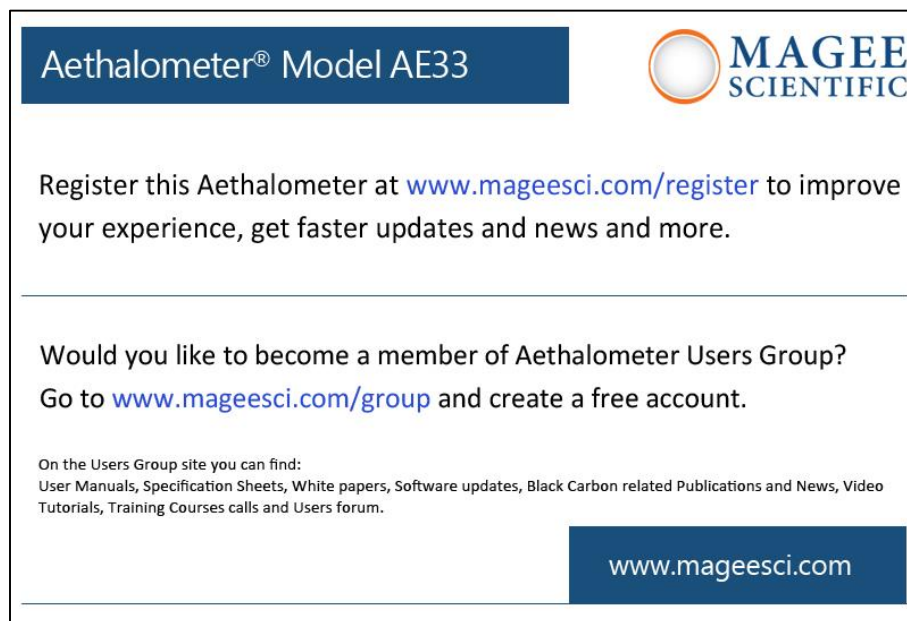

Aethalometer® Model AE33



Register this Aethalometer at www.mageesci.com/register to improve your experience, get faster updates and news and more.

Would you like to become a member of Aethalometer Users Group?
Go to www.mageesci.com/group and create a free account.

On the Users Group site you can find:
User Manuals, Specification Sheets, White papers, Software updates, Black Carbon related Publications and News, Video Tutorials, Training Courses calls and Users forum.

www.mageesci.com

8.2 Instrument Status

The Instrument Status is shown by a status flag constructed as a 16-bit value composed of codes for various instrument functions. These include the Detector Status (bits 0,1); Flow (bits 2,3); Optical Source (bits 4,5); Chamber Position (bit 6); Tape Sensors (bits 7,8); Ball Valve (bit 9); Test Procedures (bits 10, 11 and 12); and other functions as shown in the table below.

The overall Status Code Number is the **sum** of all the decimal values of all of the possible status flag values.

Status relates to:	bit position	status flag		description
		binary	decimal	
Operation	1 and 0	00	0	Measurement
		01	1	Tape advance (tape advance, fast calibration, warm-up)
		10	2	First measurement – obtaining ATN0
		11	3	Stopped
Flow	3 and 2	00		Flow OK
		01	4	Flow low/high by more than 0.5 LPM or F1 < 0 or F2/F1 outside 0.2 – 0.75 range
		10	8	Check flow status history
		11	12	Flow low/high & check flow status history
Optical Source	5 and 4	00		LEDs OK
		01	16	Calibrating LED
		10	32	Calibration error (at least one channel OK)
		11	48	LED error (all channels calibration error, COM error)

Chamber	6	0		Chamber OK
		1		Chamber error
Filter tape	8 and 7	00		Filter tape OK
		01	128	Tape warning (less than 30 spots left)
		10	256	Tape last warning (less than 5 spots left)
		11	384	Tape error (tape not moving, end of tape)
Tests & procedures	12, 11, 10	000		No test
		001	1024	Stability test
		010	2048	Clean air test
		011	3072	Change tape procedure
		100	4096	Optical test
		110	6144	Leakage test
External device	13	0	0	Connection OK
		1	8192	Connection Error
Auto clean air test status	14	0	0	Status OK or test not run yet
		1	16384	Result of clean air test is not acceptable Service of the instrument is recommended
CF card failure			32768	Problem while saving or retrieving files to/from CF card

8	7	6	5	4	3	2	1	0
0/1	0/1	0	0/1	0/1	0/1	0/1	0/1	0/1

Table 1. Status flags and explanations.

When a status flag 3 (decimal) is shown, the Aethalometer is stopped. For all other values of the status code it continues to operate with a warning, and the data is flagged accordingly.

IMPORTANT!

Measurement data is recorded for all status code values other than those indicating that the instrument has stopped or is performing programmed or manual tests. These cases are indicated by status code values of 1, 2, 3, 1024, 2048, 3072, 4096, 6144.

The overall status is a sum of the values in Table 1. These status flag add, for example:

Examples:

Status = 0, all OK -> front panel LED's GREEN

0	0	0	0	0	0	0	0	0
---	---	---	---	---	---	---	---	---

Status = 1, all OK, tape advancing -> blinking GREEN LED

0	0	0	0	0	0	0	0	1
---	---	---	---	---	---	---	---	---

Status = 128, instrument is running, tape advance warning flag is set -> YELLOW

0	1	0	0	0	0	0	0	0
---	---	---	---	---	---	---	---	---

Status = 289, $289 = 256 + 32 + 1$ -> instrument is performing a Tape Advance; there was a calibration error in one LED channel of the optical source; and the tape sensors show that only 5 tape advances remain.

1	0	0	1	0	0	0	0	1
---	---	---	---	---	---	---	---	---

The Status Code Number can be interpreted by simply pressing the status color icon on the Home Page screen. This will automatically switch the display to a screen which interprets the code value:

Instrument status:	3
Operation status:	3 - Stopped
Flow status:	0 - Flow OK
LED status:	0 - LEDs OK
Chamber status:	0 - Chamber OK
Filter tape status:	0 - Filter tape OK
Settings status:	0 - Settings OK
Tests status:	0 - No test
External device status:	0 - Connection OK
Auto clean air test status:	0 - Status OK or test not run yet
CF card status:	0 - Status OK

CHAPTER
MAINTENANCE

9. MAINTENANCE

The Aethalometer needs to be maintained regularly.

We recommend the following schedule for regular maintenance.

Check the sample inlet flow	Once / month
Inspect the sample line tubing	Once / month
Inspect and clean the size selective inlet (if present)	Once / month
Inspect and clean the insect screen assembly (if present)	Once / month
Verify time and date (if not set to update automatically)	Once / month
Inspect optical chamber, clean if necessary	Once / 6 months* *Site dependent, use educated judgment!
Flow check (flow verification, flow calibration)	Once / 6 months
Clean Air Test	Once / 6 months
Stability Test	Once / 6 months
ND filter test	Once / year
Lubricate optical chamber sliders	Once / year
Install a new filter tape roll	As needed. The instrument issues a warning.
Change by-pass cartridge filter	As needed. Once / year

Standard maintenance procedures are shown in video clips at <http://group.mageesci.com/>

9.1 Cleaning The Optical Chamber

Inspection of the optical chamber should be done twice annually as a regularly-scheduled maintenance activity. The optical chamber should also be inspected if the data are uncharacteristically noisy. This procedure will ensure that there is no dust or contamination in the optical path.

1. For this procedure you will need a can of dust-off spray, technical-grade ethanol, and cotton swabs.



2. If the measurements are running, press 'Stop'. This procedure can also be done when the instrument is powered off.

3. Open the front door to access the optical chamber.

4. Using thumb and fingers on both sides of the optical chamber, lift the chamber upwards against its springs. When the chamber is fully raised, lock it in place by pushing the metal latch. The chamber is now locked.



5. Find the release button on the front of the chamber.

6. While pressing the release button upward, grasp the lower portion of the optical head and turn it clockwise so the front of the chamber moves to the left. The lower portion will loosen from its bayonet fitting and can be removed.



7. The lower portion of the optical head consists of a translucent block. Clean all surfaces with ethanol. Put a few drops of ethanol in the openings and remove any dust or debris by using soft cotton swabs.



8. Repeat this procedure from both sides.

9. Use compressed air to remove any debris from the openings.

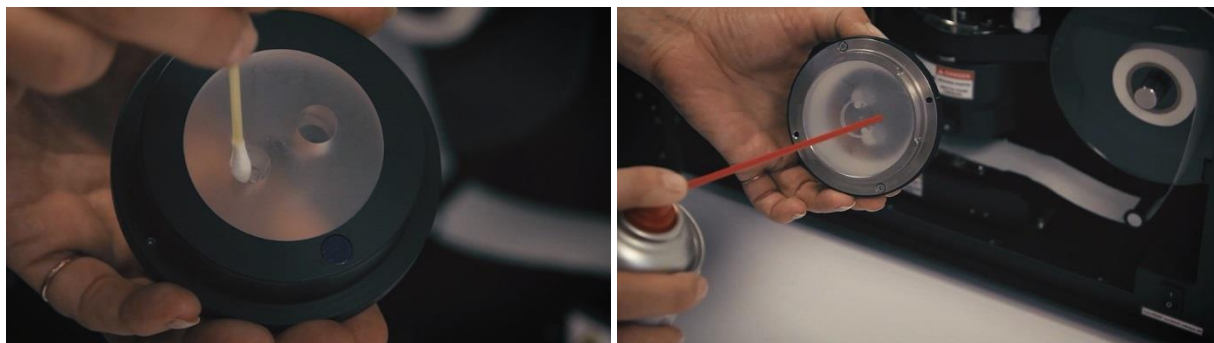

10. To re-install the optical head, first align the notched marker to the left of center; push the optical head upwards to engage the three bayonet fittings; and turn counter-clockwise (so the front of the chamber moves to the right).



12. When the chamber is fully installed, the marker line will be at the front, and the locking pin will click back into place.

13. Using thumb and fingers on both sides of the optical chamber, lift the chamber upwards. The locking latch will automatically release. Allow the chamber to return down to the tape.

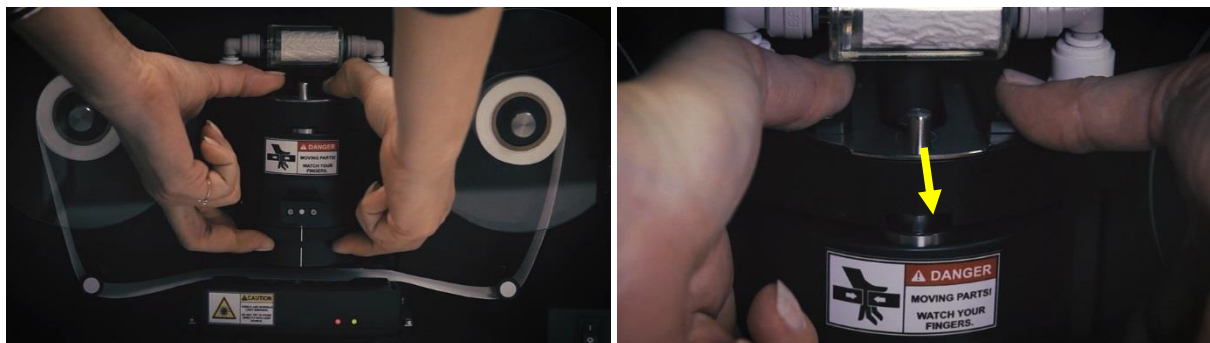

IMPORTANT: keep your fingers clear of the lower surface when releasing the chamber.

14. The cleaning procedure is now completed.

15. Restart the instrument and resume measurements.

9.2 Replacement of the Filter Tape Roll

1. For this procedure you will need the new roll of filter tape, and some adhesive tape.



Make sure you are using the correct filter tape supplied by the Magee/Aerosol. Use of any other filter tape may damage the instrument, void the warranty or lead to incorrect data.

2. If the measurements are running, press 'Stop'.

3. There are two ways to replace the tape: either using the software procedure (shown as Change Tape on the screen, with step-by-step instructions); or by manual procedures which are listed below:.

4. Open the front door of the instrument.

5. Loosen the thumb screws and remove the transparent plastic covers from both the "supply" spool (on the left hand side), and the "collection" spool (on the right-hand side).



6. Using thumb and fingers on both sides of the optical chamber, lift the chamber upwards against its springs.

7. When the chamber is fully raised, lock it in place by pushing the metal latch.



8. Remove the used tape from both spools.

9. Take the new filter tape and place it on the "supply" spool. Take note of the metal spring leaf which stabilizes the top surface of the roll.

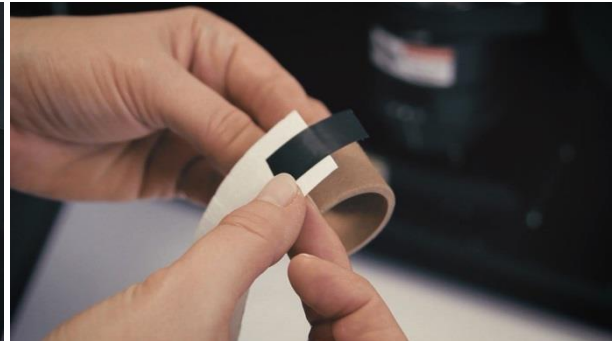

10. Make sure the roll is correctly oriented – the tape must un-roll from the left-hand side.

10. Take the other cardboard spool center and attach the end of the filter to it using adhesive tape.

11. Place the empty center on the "take-up" spool axis.



12. Make sure that the tape is fed beneath both the left and the right guide posts, and passes under the optical chamber.

13. Release the optical chamber by lifting up with thumbs and fingers on both sides. The spring-loaded latch will automatically release.

14. Replace both transparent plastic covers. Tighten the thumb screws by hand only.

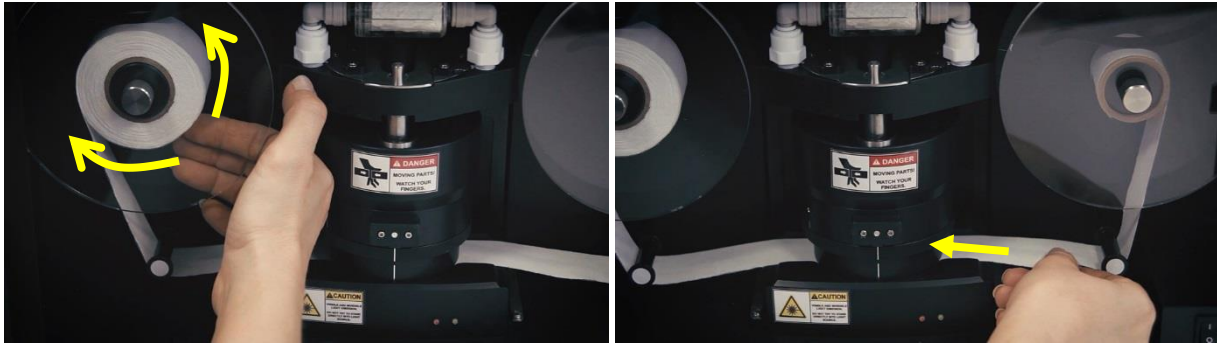

15. Check that the left-hand “supply” spool can turn freely.

16. Make sure that the right-hand “collection” spool is firmly clamped to its axis: test by gently pulling the tape, and make sure the spool center does not move.

17. The Filter Tape replacement procedure is now completed. Press 'Start' to resume operation.

9.3 Manual flow calibration

For manual flow calibration, an external standard flow-meter and the black rubber Flow Calibration Pad are needed. Please note the units and conditions of Temperature and Pressure at which the flow is reported. Please note whether the flow meter measures 'volumetric', 'standard', or 'mass' flow!

1. For this test you will need the Flow Calibration Pad (black rubber pad with two small holes) which is supplied as a standard accessory of the AE33; and an air flow meter which you will connect externally to the sample inlet port.

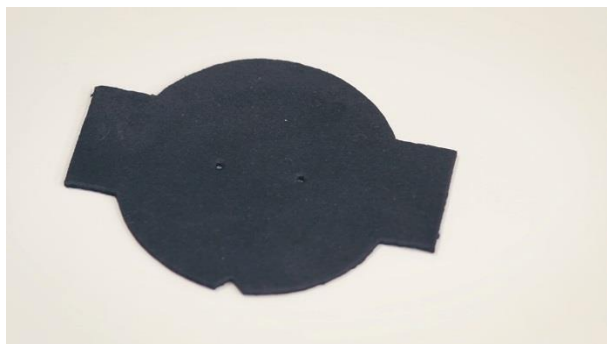

2. If the measurements are running, press 'Stop'.

3. Go to the "Operation" / "General" screen, and press the "FlowCal" button to start the test.

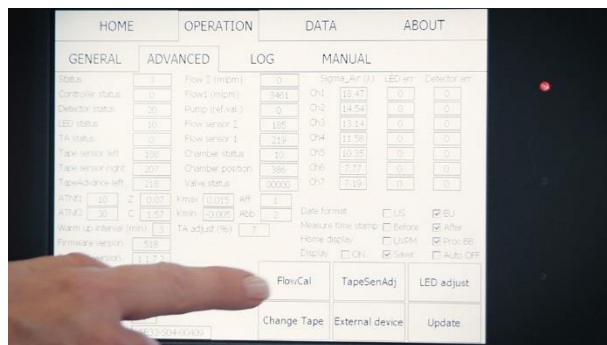

4. A new screen will appear. Choose "Manual". The "Auto" option can be only used if you are using the TSI 4110 mass flow meter connected by data cable to the AE33.

5. The instrument will run through several procedures. The first is to measure the flow through the flow calibration pad.



If the rubber pad is already in place, you can press "Skip" button. If not, please wait for the chamber to lift.

7. When prompted, remove the filter tape and install the rubber flow calibration pad with the notch facing towards you.

8. When the pad is installed, press "OK".

9. Connect the external flow meter to the inlet.

10. Connect the flow meter using well-sealed tubing and fittings. Make sure that the connections are tight.

11. Press "OK".

12. The instrument will now measure the flow at three different points: close to 1 LPM, 3 LPM, and 5 LPM.

13. Observe the flow measured by your flow meter. **IMPORTANT!** - make sure that your flow readings are reported at the same "Standard" reporting conditions of Temperature and Pressure that you are using in the Aethalometer. Many flow meters display flow at "actual" conditions (i.e. local T and P); and the same result corrected to "standard" conditions.



14. Press the input box field and enter the flow from the external flow meter.

IMPORTANT ! – units are milliliters per minute (mLPM).

15. Confirm by pressing "Enter".

16. After entering the last value (@ 5LPM) and pressing "OK", the procedure is completed.

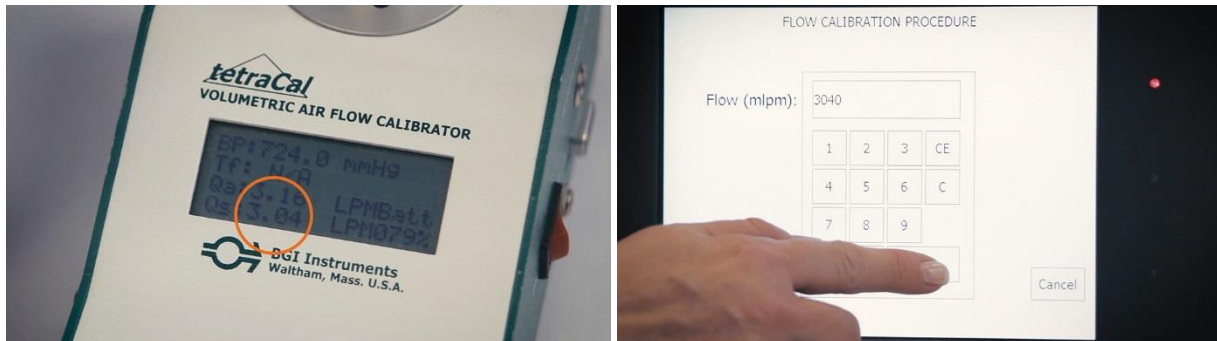

17. When finished, remove the flow calibration pad and replace the filter tape. Press "OK" when done.

18. The flow calibration procedure is now completed.

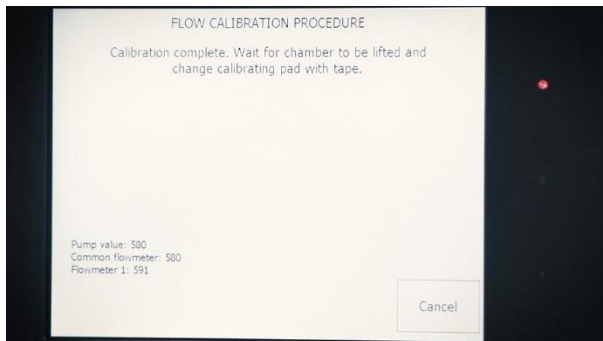

9.4 Leakage test

Leakage (“zeta”, ζ) is the difference between the flow entering the inlet port (F_{in}) and the flow passing through the system downstream of the filter (F_{out}). The difference is due to tangential leakage through the edges of the filter tape.

$$\zeta = 1 - (F_{in}/F_{out})$$

The average leakage is approximately 3% at 5 LPM. This value is taken into account during the BC calculation (chapter 5.1 Basic calculations). Its average value is entered on the “Operation” – “Advanced” screen as an operational parameter.

1. For this test you will need the Flow Calibration Pad (black rubber pad with two small holes) which is supplied as a standard accessory of the AE33; and an air flow meter which you will connect externally to the sample inlet port.



2. If the measurements are running, press 'Stop'.

3. Go to the "Operation" / "General" screen, and press the "Leakage test" button to start the test.

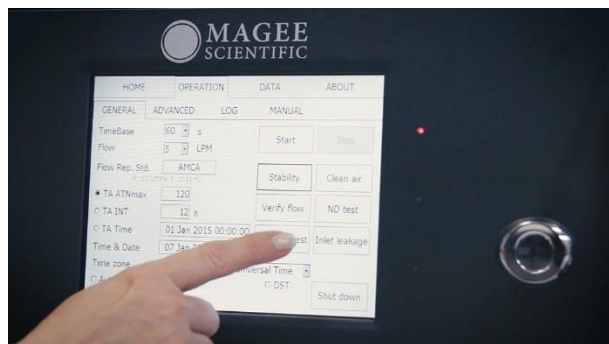

4. A new screen will appear. Choose "Manual". The "Auto" option can be only used if you are using the TSI 4110 mass flow meter connected by data cable to the AE33.
5. The instrument will first measure the flow through the filter tape.
6. Confirm by pressing "OK" button.
7. Connect your external mass flow meter to the inlet port.
8. Connect the flow meter using well-sealed tubing and fittings. Make sure that the connections are tight.



10. Press "OK".
11. Choose the flow at which you want to perform the test. Normally this test is conducted at 5 LPM. Press "OK"

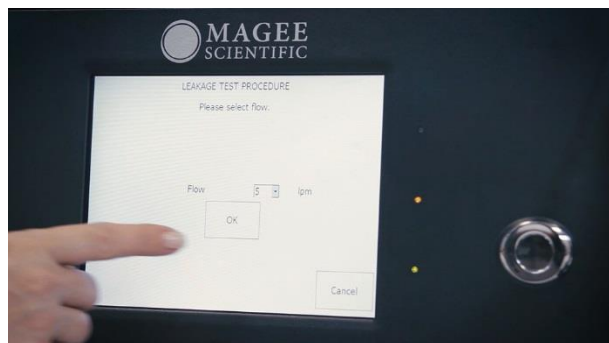

14. Observe the flow measured by your flow meter. **IMPORTANT !** - make sure that your flow readings are reported at the same “Standard” reporting conditions of Temperature and Pressure that you are using in the Aethalometer. Many flow meters display flow at “actual” conditions (i.e. local T and P); and the same result corrected to “standard” conditions.

15. Press the input box field and enter the flow from the external flow meter.

IMPORTANT ! – units are milliliters per minute (mLPM).

16. Confirm by pressing "OK".

17. The second part of the procedure is to measure the flow once again: but through the rubber flow calibration pad, rather than the filter tape.

18. When prompted, remove the filter tape and install the rubber flow calibration pad with the notch facing towards you.



19. When ready, press "OK".

20. Repeat the procedure as before when measuring the flow through the filter tape.

21. When finished, remove the flow calibration pad and replace the filter tape. Press "OK" when done.

22. The test is now completed.

23. The report shows: Instrument serial number, date and time of the test, and the results of the test - selected flow and flows through the filter tape and calibration pad.

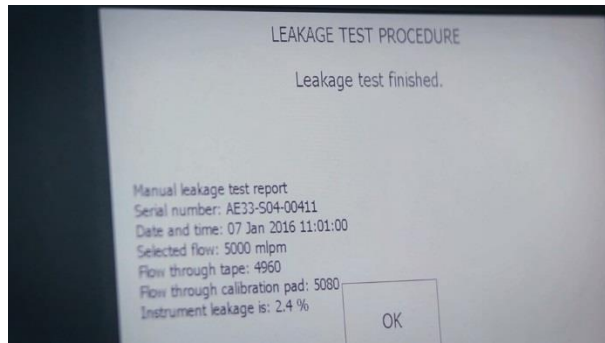

This report is also saved on the CF card and is available for download with data files.

24. The leakage should be less than 10%. If the reported leakage is larger than 10%, please contact Magee Scientific, Aerosol, or your authorized distributor.

9.5 Stability test

The Stability Test determines the performance of the light source and detector, without air flow through the system.

To perform this test, select Operation/General/Stability Test. The Stability Test duration is 20 minutes, during which a Status Code of 1024 will be shown. At the end of the test, a report is generated and saved to the CF card.

1. If the measurements are running, press 'Stop'.
2. Go to the "Operation" / "General" screen, and press the "Stability Test" button in order to start the test.
3. A new screen appears listing all relevant information about the test settings (test duration, flow and timebase).



4. When ready, press "OK".
5. The instrument will now start with the test.
6. The test will automatically stop after 20 minutes.

IMPORTANT: if you want the instrument to automatically proceed with BC measurements after the Stability Test, please be sure to check the box "continue after test" before starting.

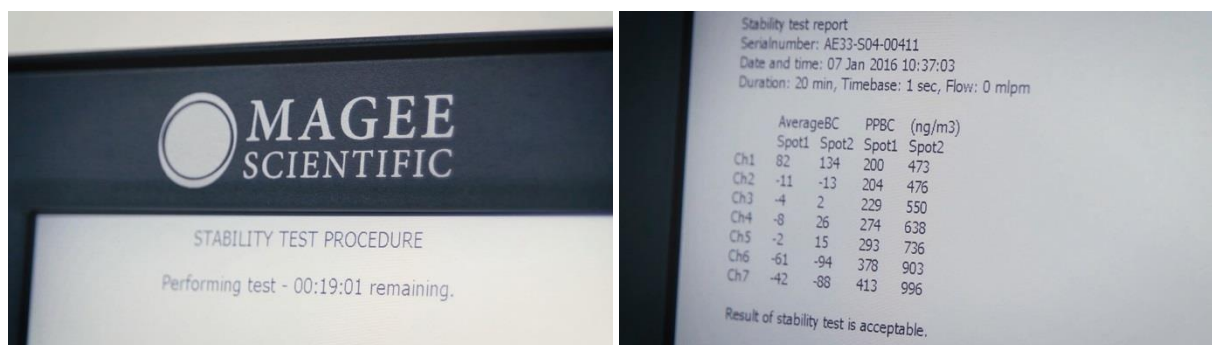

7. The Stability test procedure report will be generated and shown on the screen. A separate report will be generated and saved on the CF card for later download.
8. The test result is acceptable if the value of PPBC on Spot1 is lower than 450 ng/m³ for Channel 6. If the reported value of PPBC on Spot 1 is larger than this value, please contact Magee Scientific, Aerosol or your authorized distributor.
9. Confirm completion of the test by pressing "OK".

The 'Average BC' values should be close to zero (less than +/- 100) if the Aethalometer is warmed up and stabilized for at least one hour.

9.6 Clean Air test

The Clean Air test is conducted using the built-in filter to determine the stability and performance of the Aethalometer under the air flow conditions.

To perform the clean air test, select Operation/General/Clean air test. The Clean Air Test duration is 20 minutes, during which a Status Code of 2048 will be shown. At the end of the test, a report is generated and saved to the CF card.

1. If the measurements are running, press 'Stop'.
2. Go to the "Operation" / "General" screen, and press the "Clean Air" button in order to start the test.
3. A new screen appears listing all relevant information about the test settings (test duration, flow and timebase).



4. When ready, press "OK".
5. The instrument will now start with the test.
6. The Clean Air test uses a built-in filter to determine the stability and performance of the Aethalometer under dynamical conditions of air flow. Air is drawn through a cartridge filter (mounted on the top of the optical chamber), and this particle-free air then flows through the analytical system.

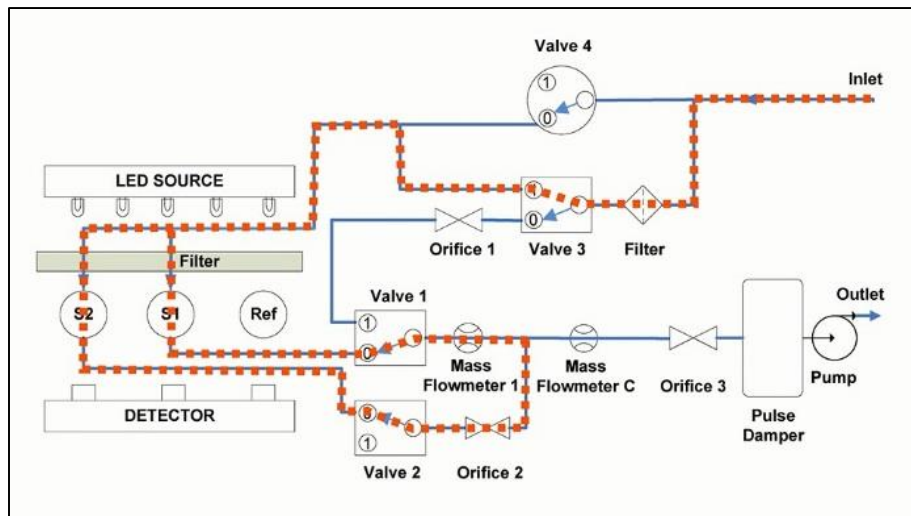

6. After 20 minutes the test will automatically stop.

IMPORTANT: if you want the instrument to automatically proceed with BC measurements after the Clean Air Test, please be sure to check the box "continue after test" before starting.

7. The Clean air test procedure report will be generated and shown on the screen. A separate report will be generated and saved on the CF card for later download.

Clean air test report
 Serialnumber: AE33-S04-00409
 Date and time: 07 Jan 2016 11:02:03
 Duration: 20 min, Timebase: 1 sec, Flow: 5000 mlpm

	AverageBC		PPBC (ng/m3)	
	Spot1	Spot2	Spot1	Spot2
Ch1	150	300	183	507
Ch2	13	51	200	540
Ch3	14	60	221	611
Ch4	41	208	253	652
Ch5	58	205	279	707
Ch6	6	135	387	1020
Ch7	62	158	415	1122

Result of clean air test is acceptable.

8. The test result is acceptable if the value of PPBC on Spot1 is lower than 550 ng/m3 for Channel 6. If the reported value of PPBC on Spot 1 is larger than this value, please contact Magee Scientific, Aerosol or your authorized distributor.

9. Confirm completion of the test by pressing "OK".

The average BC values should be close to zero (less than +/- 100) if the Aethalometer is warmed up and stabilized for at least one hour. Occasionally, a short transient may be seen at first, due to a filter compression artifact.

9.7 Automatic Clean Air Test

The Automatic Clean Air Test is activated by checking “Auto Clean Air” option on the Operation/General screen. It can run on a weekly or monthly schedule at a specified time.

The test duration is 20 minutes and it is run at a flow rate of 5 LPM, 1 second time base. During the test, the Status Flag is set to 2048. The test results are displayed in the log file: average BC concentrations and point-to-point variations are calculated for each channel and each spot. After the test, a report is generated (see section 9.6 Manual clean air test). If the test result is not acceptable, a warning status code value of 16384 is generated.

9.8 Tape Sensor calibration

The amount of tape on the “Supply” and “Collection” spools is determined by two optical sensors which measure the diameter of each roll. These sensors are in the form of small optical lenses on each side of the Analysis Unit headframe. The Tape Sensors should be cleaned periodically; and their measurement response **must** be re-calibrated if the Analysis Unit is ever removed from the instrument and re-installed. **This procedure requires the special Spool Diameter Calibration Cylinders** (see section 15 *Accessories*) which are two cylinders covered with filter tape. The smaller cylinder has a diameter of 39 mm; the larger cylinder has a diameter of 102 mm.

To re-calibrate Tape Sensors, first stop the measurements. Next, select the “TapeSenAdj” button on the Operation/Advanced screen, and follow the on-screen instructions which require installing the calibration cylinders alternately on both spools. Note that it is essential

to cover the calibration cylinders with the clear plastic spool front-plates during the calibration process, for correct optical response.

9.9 Flow verification

The Flow Verification routine allows the operator to check if the internal flow sensors are responding accurately. No instrument settings are changed during the flow verification process. The process is also shown on the video library available on the Magee Scientific website.

1. This test requires the black rubber Flow Calibration Pad (supplied with every instrument); and an air mass flow meter connected externally to the sample inlet port.

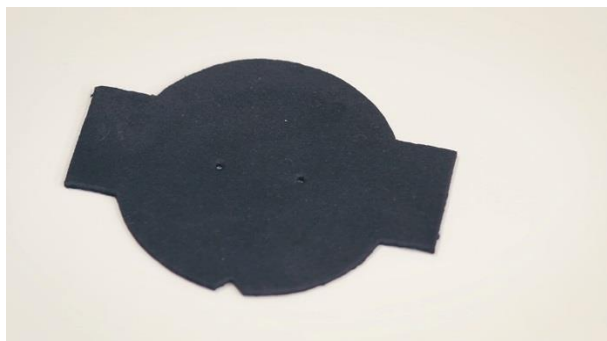

2. Go to the "Operation / General" screen. If the measurements are running, press 'Stop'.
3. Press the "Verify flow" button to start the test.



4. A new screen will open. Choose "Manual". The "Auto" option can be only used if you are using the TSI 4110 mass flow meter connected by data cable to the AE33.

5. The first part of the routine is to measure the flow through the flow calibration pad.



6. Wait for the chamber to lift: when prompted, remove the filter tape and install the rubber flow calibration pad with the notch facing towards you.

7. When installed, press "OK".

8. Connect your external air mass flow meter to the inlet port.

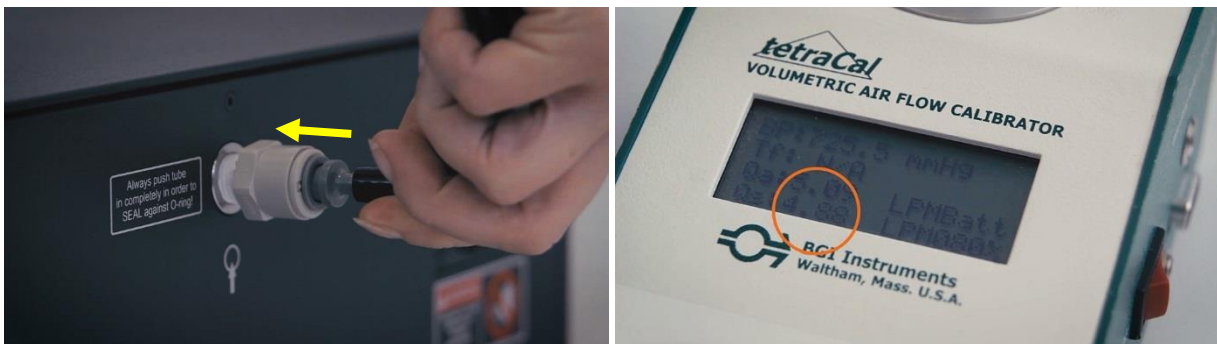

9. Connect the flow meter using well-sealed tubing and fittings. Make sure that the hose connection is tight.

10. Press "OK".

11. The Flow Verification routine will measure the flow at three different values (close to 1 LPM, 3 LPM, and 5 LPM), and compare the "internal" value (from the instrument's flow sensors) with the "external" value measured by the external flow meter.

12. Note the flow on your external mass flow meter.

IMPORTANT! - make sure that your flow readings are reported at the same reporting conditions of T and P as the instrument's setting.

13. Press the empty box marked 'Flow' and enter the flow from the external flow meter.
IMPORTANT ! – units are milliliters per minute (mLPM).
14. Confirm by pressing "OK". The process will repeat at the three flow values.
15. After entering the last value (@5LPM) and pressing "OK", the instrument will show the flow verification report. This report is also saved on the CF card and is available for download with data files.



16. The test is satisfactory if the difference of flow readings is less than +/-10%.

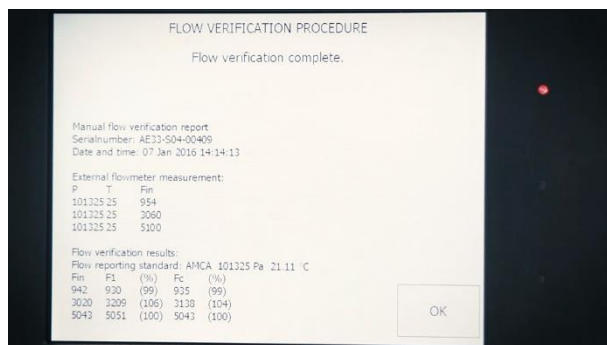

If the difference is larger, re-calibration of the flow sensors is needed (see section 9.3).

17. Confirm by pressing the "OK" button.
18. When prompted, remove the rubber flow calibration pad and re-install the filter tape.
Press "OK" when done.
19. The test is now complete, and normal operation can resume.

9.10 ND Optical Filter test

The 'Neutral Density Optical Filter' test routine is used to verify the performance of the optical system, namely the response of the optical detectors to varying intensities of light from the optical sources. The ND Test uses 4 optical elements, each fitted with inserts of Neutral Density glass which have stable and standards-traceable optical absorbance. The routine compares the measured attenuation values for each glass element at each wavelength, versus the calibrations at the time of manufacture. The data is analyzed as a linear fit: if the slope differs more than 10% from unity, the test fails.

1. For this test you will need the ND Optical Filter Kit box, which consists of 4 different optical elements.
2. Go to the "Operation / "General" screen. If the measurements are running, press 'Stop'.
3. Press the "ND test" button to start the test.
4. A new screen will ask you to enter the ND Kit Serial Number, marked on the box.

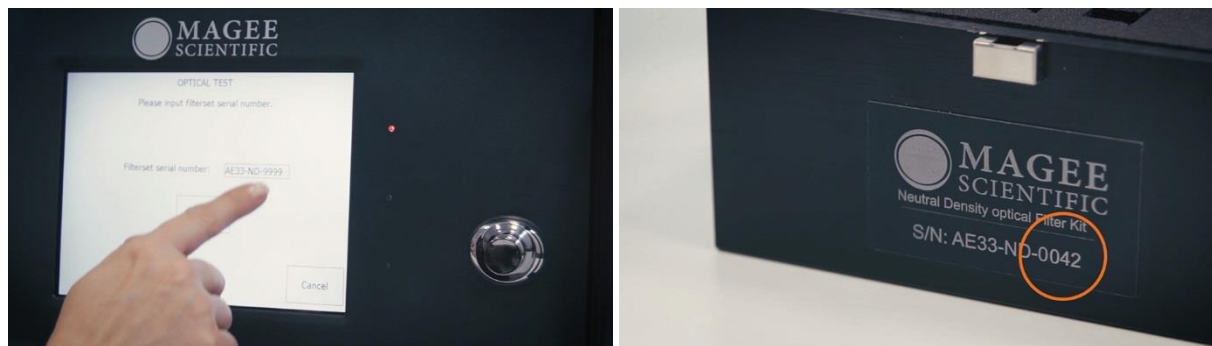

5. Press the input field and enter the Serial Number of the ND Kit.
6. Confirm by pressing "Enter" and "OK" button.
7. If this is the first time the ND Test has been performed on this instrument, it will prompt you for a file of calibration parameters. These must be uploaded from the USB memory stick that is included in the ND kit box.
8. Insert the USB stick into the USB port on the front panel, and press "Yes".
9. The instrument will copy the calibration parameters file and then start the test procedure.

10. ALWAYS KEEP THE FILTER TAPE IN POSITION ACROSS THE ANALYTICAL AREA.

When prompted, insert ND element No. 0 (zero) **ON TOP OF** the filter tape. **DO NOT TOUCH** the glass – hold it by the metal studs. Insert it with the “V” notch facing forwards.



11. Press "OK" when inserted. Watch the screen, and remove the filter disk when prompted.

12. Repeat the same procedure when prompted for ND elements 1, 2 and 3.

13. The test is completed after ND element No. 3 is removed.

14. The instrument will generate a report which shows the instrument serial number, date and time of the test; and the results of the test. This report is also saved internally and is available for future download.

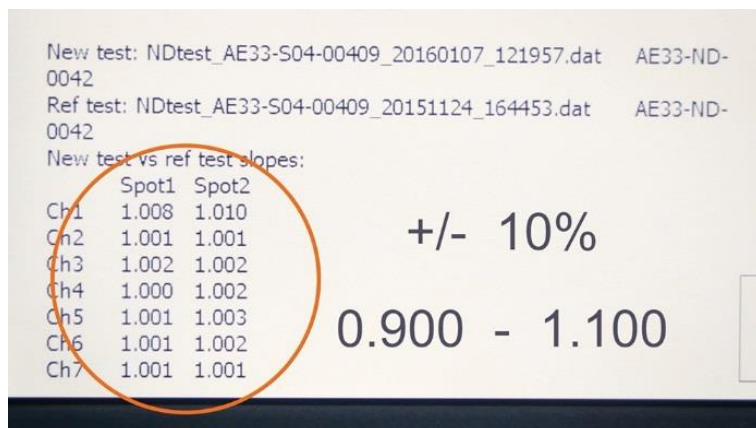

15. Correct operation is shown by report values on both spots (Spot1 and Spot2) within +/- 10% of 1.000 : i.e., between 0.9 and 1.1 for all seven wavelengths (Ch1 to Ch7).

16. If for any reason the results fall outside this range even after repeating the test, please contact Magee Scientific, Aerosol Co., or your authorized distributor.

9.11 Inlet Leakage test

The Inlet Leakage test is used to test the integrity of the inlet system, from the point of sample entry to the instrument's analytical area. In many cases, the sample entry point is outdoors, while the instrument is indoors. This test will detect any leakage throughout the entire system.

The test routine compares two measurement values from an external flowmeter: one taken at rear port of the instrument, and the other at the sample point of entry (which may be outdoors). The routine requires the use of the black rubber Flow Calibration Pad.

The Inlet Leakage test is accessed from the 'Operation/General' screen, press the box Inlet Leakage Test. During this test, data will be flagged by status code 6144. Follow the instructions on the screen to insert the Flow Calibration Pad, and measure the flows using an external flow meter at the two points. When the test is finished, a report is generated which is also saved internally for future download:

Inlet leakage test report
Serial number: AE33-S00-00027
Date and time: 30 Jun 2015 14:10:00
Selected flow: 5000 mlpm
Instrument inlet flow: 4700
Outdoor inlet flow: 4500
Instrument leakage is: 4.3 %

The leakage should be less than 10%. If the reported leakage is larger than 10%, please contact Magee Scientific, Aerosol or your authorized distributor.

9.12 Lubrication of Optical Chamber Sliders

1. For this procedure you will need silicon grease and a cotton swab.



2. If the measurements are running, press 'Stop'. This procedure can also be done when the instrument power is switched off.
3. Open the front door of the Aethalometer.
4. Put a small amount of grease on the cotton swab.



5. Apply the grease on all three sliders (vertical shafts) of the optical chamber. Try to apply the grease uniformly over the whole length of the sliders.
6. Grasp the optical chamber with thumb and fingers on both sides, and move it up and down against its springs several times. This will distribute the grease over the full range of the sliders.



9.13 Cartridge Filter Replacement

The bypass cartridge filter is located above the optical chamber and is clearly visible behind the front door. It should be changed on an annual basis, or earlier if needed at stations with high aerosol loading. This is indicated if the filter color is darker than “medium gray”, looks blackened and dirty, or if the Clean Air test results yield a BC concentration much higher than zero.

1. For this procedure you will need a new cartridge filter, and a medium-size flat screwdriver.
2. The cartridge filter is located on the top of the optical chamber.



3. If the measurements are running, press 'Stop'. This procedure can also be done when the instrument power is switched off.
4. Open the front door to access the cartridge filter. Note the orientation of the air flow indicator arrow, from left to right.
5. The filter and its fittings are installed in "grip adapters" which must be released by pressing down using a flat screwdriver.
6. Press down on the white ring of the outer grip connector on one side of the filter and pull the elbow connector up and out of the connector.

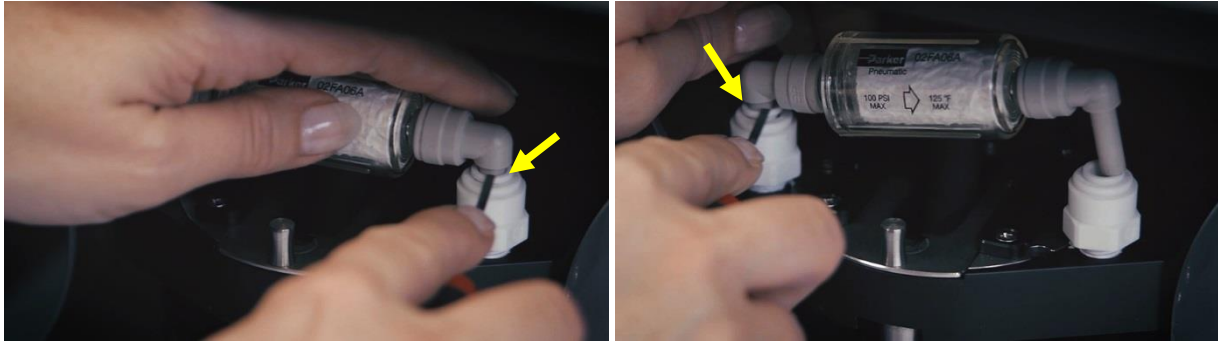

7. Repeat on the other side, so that the cartridge is removed with its two elbow connectors.
8. Remove the elbow connectors from the filter itself, this time pressing the grey ring of the connector.

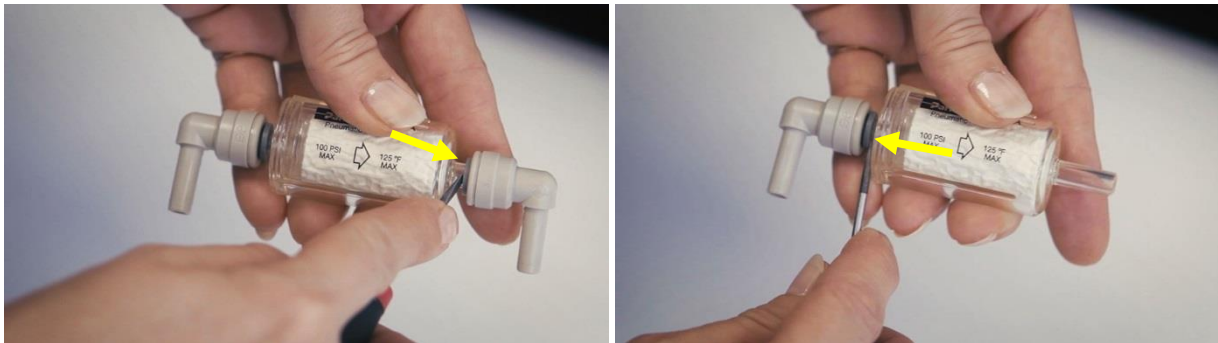

9. Take a new filter and attach both elbow connectors to this filter with the same orientation of the flow indicator arrow.

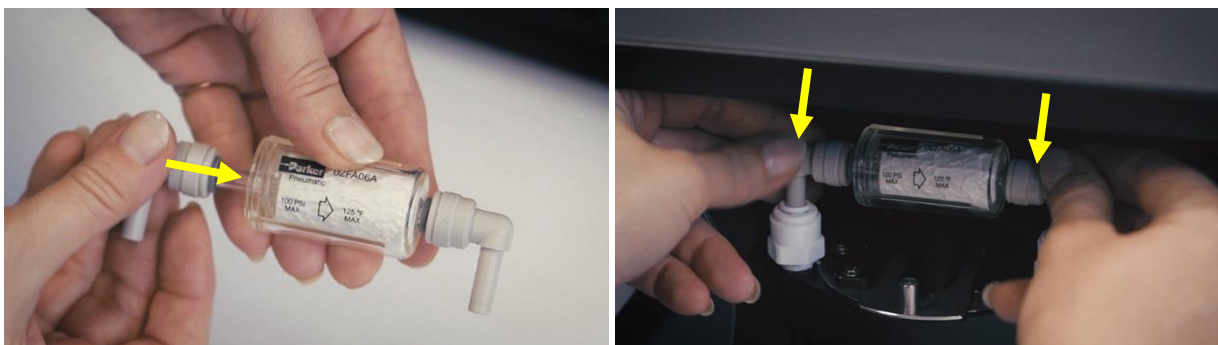

10. Install the filter by pressing the elbow connectors firmly down onto the sockets.
11. Restart the instrument and continue measurements.

CHAPTER
SERIAL COMMANDS

10. SERIAL DATA PORT CONNECTIONS

All commands finish with a Carriage Return. Note that all commands must be sent as UPPERCASE characters.

\$AE33:Dnnn	nnn = number of lines of data requested		Request nnn last data lines
\$AE33:Wnnn	nnn = number of lines of data requested		Request nnn last measurements. Same as \$AE33:Dnnn, except that BC _{BB} (ng/m ³) is reported instead of BB (%)
\$AE33:TyyyyMMddHHmmss	yyyy	year	Synchronize time with an external device (e.g. datalogger)
	MM	month	
	dd	day	
	HH	hour (24)	
	mm	min	
	ss	second	
\$AE33:A			Report tape advances remaining
\$AE33:SG			Get setup file
\$AE33:SSn m	n = parameter name m = parameter value		Set setup parameter Example: \$AE33:SSTimebase 1 Note: instrument must be stopped
\$AE33:Lnnn	nnn = number of log entries requested		Request nnn last log entries
\$AE33:Fn m	n = folder name (Data, NDtest, CleanAirTest, StabilityTest,		Get file(s) – starts streaming number of files

	InletLeakageTest, LeakageTest, Flow) m = number of files (0 = all)	
\$AE33:E		Stop streaming data
\$AE33:Xn	n = 0 :- instrument stop n = 1 :- instrument start	Remote start/stop

IMPORTANT!

The command **must be sent as a string, not as separate characters.**

We recommend using RealTerm as a communications program (available for free download): it has extended functionality and improved 'send' options.

'Hyper Terminal' may be used, by sending a file with a command. However, Hyper Terminal may experience problems if the string includes more than two consecutive identical numbers (111, for example).

Example 1: \$AE33:D1[CR] => 9 bytes: output will be one line of data.

Example 2: \$AE33:D120[CR] => 11 bytes; Output will be 120 lines of data.

Example 3: \$AE33:T20120110120000[CR] will synchronize the time on the Aethalometer to 10 Jan 2012, 12 noon. If the instrument was either measuring; or performing the stability, clean air or auto clean air tests; the command stops the instrument and returns it to the operating state before change. In all the other cases it only changes the time.

10.1 External devices

External devices may be connected to the three serial COM ports of the AE33 Aethalometer. These include data-loggers, as well as instrument accessories. The 'Operation/Advanced' screen offers the "External device" dialog to select the interface for each COM port. After making the physical connection on the rear panel, select the device from the drop-down list and click "Connect". The Aethalometer will send a query to the external device. When the connection is made, the status indicator will be shown in green. If there is a connection problem the status will be shown as yellow, and the code value 8192 is added to the instrument status.

Devices which are supported at present include:

- AMES_TPR159 (ID_com = 1) – dedicated ambient temperature + relative humidity + pressure sensor used for flow reporting at ambient conditions
- Comet_T0310 (ID_com = 2) – temperature sensor
- Vaisala_GMP343 (ID_com = 3) – CO2 sensor
- TSI_4100 (ID_com = 4) – mass flowmeter
- Datalogger_AE33_protocol (ID_com = 5) – the port is enabled for communication with the data-logger
- Aerosol_inlet_dryer (ID_com = 6) – temperature, RH, dew point sensor
- Datalogger_BH_protocol (ID_com = 7) – Bayern - Hessen protocol
- Datalogger_Qair_protocol (ID_com = 8) – communication protocol for digital links with 'Qair' air quality data acquisition stations
- AE33_data streaming (ID_com=9) – data streaming enabled on the selected COM port

10.1.1 AMES TPR159

Data received from the AMES sensor (T, P, RH) is stored at the end of the AE33 dataline in the “Fields_i” section in the following format: Temperature, RH, Pressure. If the flow reporting standard is selected as “Ambient”, the values of Temperature and Pressure in the dataline are the same as in the “Fields_i” section.

10.1.2 Comet T0310

The Comet sensor outputs temperature. This data is stored in the “Fields_i” section.

10.1.3 Vaisala GMP343

The Vaisala sensor reports CO₂ data, which is stored at the end of AE33 dataline in the ‘Fields_i’ section in following format: CO₂, CO₂RAW, Temperature.

10.1.4 TSI 4100

The TSI-4100 is a mass flowmeter. It may be used for Automatic calibration, in which case it must be connected to the COM3 port. Its flow data is stored in the ‘Fields_i’ section.

10.1.5 Datalogger AE33 protocol

Please check the table in section 10 for more details.

10.1.6 Sample Stream Dryer

The Sample Stream Dryer transmits the following data: temperature, RH and dew point at the inlet; and temperature, RH and dew point at the outlet. This data is stored in the ‘Fields_i’ section.

10.1.7 “Bayern Hessen” datalogger protocol

The instrument supports data acquisition using the BH protocol. The basic command is: <STX>DA<address><ETX><BCC>. This command initiates a data transfer from the instrument. The address (a value between 1 and 255) is optional and can be set on the ‘Operation / Advanced’ screen as “External ID”.

The instrument responds to a valid command in the following format:

```
<STX>MD07<SP><address><BC1><SP><opStatus><SP><errStatus><SP>0000000000<SP>....  
....  
<address><BC7><SP><opStatus><SP><errStatus><SP>0000000000<SP><ETX><BCC><CR><LF>
```

<address> is the instrument address.

<BC1> ... <BC7> are 7 BC values, shown in exponential representation with 4 characters mantissa and 2 characters exponent.

<opStatus> is the status of the operation state:

- 00000000 – measuring,
- 00000001 – tape advance,
- 00000010 – ATN_zero measurement,
- 00000011 – instrument stopped,
- 00000100 – LED calibrating,
- 00100000 – clean air test,
- 01000000 – stability test,
- 01100000 – tape change,
- 10000000 – optical test,
- 11000000 – (inlet) leakage test.

<errStatus> is the status of instrument problems:

- 00000000 – no error,
- 00000010 – flow problem,
- 00000100 – led problem,
- 00001000 – chamber problem,
- 00010000 – external device problem.

10.1.8 Datalogger Qair protocol

The instrument supports data acquisition over the ‘Qair’ protocol which complies with the “Communication protocol for digital links with air quality data acquisition stations ver. 3.1”. This is a limited version of the industrial JBUS communication protocol.

The standard command format is: <slave number><function code><address><number of words><CRC16>

<Slave number> - Instrument External ID, values from 1 – 255. (1 byte)

<Function code> - Supported function code is 3. (1 byte)

<address> - Supported address values are 0,10,20,30,34,37,179,187 (all decimal). (2 bytes).

<Number of words> - Number of words in the response message. (2 bytes)

<CRC 16> - checksum. (2 bytes).

Examples:

Manufacturer (address code 0)

- Command: [01] [03] [00] [00] [00] [0A] [C5] [CD]
- Response: [1] [3] [14] [4D] [61] [67] [65] [65] [20] [73] [63] [69] [65] [6E] [74] [69] [66] [69] [63] [20] [20] [20] [20] [5C] [8E]

Serial number (address code 10)

- Command: [01] [03] [00] [0A] [00] [0A] [E5] [CF]
- Response: [1] [3] [14] [41] [45] [33] [33] [2D] [53] [30] [30] [2D] [30] [30] [30] [32] [37] [20] [20] [20] [20] [20] [20] [20] [62] [9E]

Software and firmware version (address code 20)

- Command: [01] [03] [00] [14] [00] [0A] [85] [C9]
- Response: [1] [3] [14] [31] [2E] [31] [2E] [37] [2E] [31] [20] [35] [31] [38] [20] [20] [20] [20] [20] [20] [20] [20] [F6] [E]

Date (address code 30)

- Command: [01] [03] [00] [1E] [00] [04] [24] [0F]
- Response: [1] [3] [8] [30] [32] [30] [37] [32] [30] [31] [35] [7D] [A3]

Time (address code 34)

- Command: [01] [03] [00] [22] [00] [03] [A5] [C1]
- Response: [1] [3] [6] [31] [30] [34] [38] [35] [30] [81] [1E]

Operating parameters (address code 37)

- Command: [01] [03] [00] [25] [00] [64] [55] [EA]
- Response: [1] [3] [84] [0] [0] [0] [1] [0] [0] [13] [88] [41] [93] [C2] [8F] [41] [68] [A3] [D7] [41] [52] [3D] [71] [41] [39] [47] [AE] [41] [25] [99] [9A] [40] [F8] [A3] [D7] [40] [E6] [14] [7B] [3F] [48] [F5] [C3] [42] [F0] [0] [0] [C5] [14] [5B] [2B] [C5] [41] [6F] [17] [41] [50] [B8] [86] [41] [6F] [BB] [F7] [BA] [59] [CF] [DF] [BB] [13] [76] [3] [43] [37] [AC] [1C] [3D] [9C] [8B] [3C] [35] [5B] [EF] [D2] [3F] [94] [D] [AA] [C1] [ED] [D0] [38] [3F] [97] [E4] [B4] [C2] [70] [A3] [D7] [3D] [8F] [5C] [29] [3F] [C8] [F5] [C3] [41] [20] [0] [0] [41] [F0] [0] [0] [3C] [75] [C2] [8F] [BB] [A3] [D7] [A] [0] [0] [0] [0] [41] [A8] [E1] [48] [47] [C5] [E6] [80] [6] [81]

Each parameter is 4 bytes. Parameters list: timebase, flowset, SG(1-7), Area, ATN_max.

FlowFormula(A0,A1,B0,B1,C0,C1,D,E,F), TapeFormula (RightK,RightN,LeftK,LeftN), Zeta, C, ATNf1,ATNf2, FlowReference, Tm, Pm.

- Alarms (address code 179)
 - Command: [1] [3] [4] [0] [0] [0] [83] [F3] [5D]
 - Response: [1] [3] [4] [0] [0] [0] [83] [F3] [5D]

Status value converted to 4 bytes.

- Instantaneous values (address code 187)
 - Command: [01] [03] [00] [BB] [00] [3C] [35] [FE]
 - Response: [1] [3] [D2] [84] [0] [0] [0] [12] [9C] [84] [0] [0] [0] [0] [D1] [84] [0] [0] [0] [13] [6D] [84] [0] [47] [C5] [E6] [80] [84] [0] [41] [A8] [E1] [48] [84] [0] [41] [64] [83] [B9] [84] [0] [44] [93] [30] [F2] [84] [0] [45] [CB] [38] [32] [84] [0] [44] [93] [58] [E9] [84] [0] [44] [A6] [52] [DC] [84] [0] [46] [7] [E0] [1B] [84] [0] [44] [A6] [75] [C7] [84] [0] [44] [88] [11] [54] [84] [0] [44] [CD] [D6] [5A] [84] [0] [44] [88] [2A] [7F] [84] [0] [44] [95] [4F] [3E] [84] [0] [46] [A] [6E] [94] [84] [0] [44] [95] [69] [99] [84] [0] [44] [AC] [AB] [37] [84] [0] [C5] [4] [70] [8D] [84] [0] [44] [AC] [C6] [E1] [84] [0] [44] [A5] [62] [D0] [84] [0] [0] [0] [0] [0] [84] [0] [44] [A5] [77] [82] [84] [0] [44] [91] [45] [A4] [84] [0] [46] [3F] [9B] [3E] [84] [0] [44] [91] [57] [4C] [84] [0] [3B] [B2] [58] [57] [84] [0] [3B] [C3] [C8] [3] [84] [0] [3B] [CE] [81] [3C] [84] [0] [3B] [D7] [DE] [7] [84] [0] [3B] [E4] [EE] [48] [84] [0] [3C] [0] [A8] [48] [84] [0] [3C] [4] [D7] [D7] [84] [0] [0] [0] [0] [1E] [3A] [56]

Individual data values are encoded into groups of 6 bytes each. The first 4 bytes are the value, and second two bytes are status. List of values: Flow1, Flow2, FlowC, Pm, Tm, ProcBB, BC1(i),BC2(i),BC(i) (i=1-7),KoefSen(i) (i=1-7), TapeAdvanceLeft.

10.1.9 AE33 data streaming

Data is automatically transmitted through a COM port using the communication parameters of “9600.8N1” (9600 baud; 8 bits; No parity; 1 stop bit). The data line format is the same as in the AE31 instrument. Data values are delimited by commas (CSV).

Columns:

- instrument serial number (last 4 digits)
- date ("dd-MMM-YY")
- time("HH:mm")
- BC1, BC2, BC3, BC4, BC5, BC6, BC7
- FlowC (lpm)
- 42 columns with diagnostic values in “0.0” format

10.2 Connecting to External Datalogger or PC

Connect with a crossover cable (or standard serial cable with null modem adapter) from the PC / Datalogger to the serial port of the instrument on the rear panel.

Establish communications using the following values:

BaudRate = 115200

DataBits = 8

StopBits = 1 (IO.Ports.StopBits.One)

Parity = None (IO.Ports.Parity.None)

Handshake = None (IO.Ports.Handshake.None)

DTR_Enable = True

RTS_Enable = True

Note: the BH and Qair protocols use these connection parameters above.

CHAPTER
DATA HANDLING

11. DATA MANAGEMENT

11.1 Exporting the Data

Insert a USB memory stick in either of the front USB ports: do not use the USB port on the rear panel.

Go to the “Data / Export” screen and press “Export to USB”.

HOME	OPERATION	DATA	ABOUT
TABLE	EXPORT		
Free space: 55 year(s) and 228 day(s) left			
<input checked="" type="checkbox"/> Delete Oldest If Full	<input type="checkbox"/> Delete after copy	DeleteCFdata	Sys restore
From: 24 Aug 2013	To: 18 Oct 2013		
<input checked="" type="checkbox"/> Copy LOG			
<input checked="" type="checkbox"/> Copy ND test results			
<input checked="" type="checkbox"/> Copy Flow verification result			
ExportToUSB			

The data will be stored in a text file with a header. The file name is:

AE33_Sss- nnnnn_yyyymmdd.dat

where ss is the production series number, nnnnn is the serial number, and yyyymmdd is the date, for example 20120901 means 1 Sept 2012.

Please make sure that the transfer is finished before removing the USB memory stick from the USB port on the Aethalometer. We recommend that all data downloaded to portable USB memory sticks should subsequently be uploaded to permanent archives.

Data file structure and description of the fields

Header:

Date(yyyy/MM/dd); Time(hh:mm:ss); Timebase; RefCh1; Sen1Ch1; Sen2Ch1; RefCh2; Sen1Ch2; Sen2Ch2; RefCh3; Sen1Ch3; Sen2Ch3; RefCh4; Sen1Ch4; Sen2Ch4; RefCh5; Sen1Ch5; Sen2Ch5; RefCh6; Sen1Ch6; Sen2Ch6; RefCh7; Sen1Ch7; Sen2Ch7; Flow1; Flow2; FlowC; Pressure (Pa); Temperature (°C); BB (%); ContTemp; SupplyTemp; Status; ContStatus; DetectStatus; LedStatus; ValveStatus; LedTemp; BC11; BC12; BC1; BC21; BC22; BC2; BC31; BC32; BC3; BC41; BC42; BC4; BC51; BC52; BC5; BC61; BC62; BC6; BC71; BC72; BC7; K1; K2; K3; K4; K5; K6; K7; TapeAdvCount; ID_com1; ID_com2; ID_com3; fields_i

Data line:

2012/09/21 00:34:00 60 890416 524323 709193 823296 573862 756304 884844 619592 789142
822391 673266 816066 792706 686925 828401 738101 718325 841075 789053 722690 833686
3325 1674 4999 101325 21.11 -1 30 40 0 0 10 10 00000 0 1150 1290 1242 1166 1248 1215 1150
1231 1190 1146 1196 1175 1214 1195 1234 1144 1114 1139 1180 1225 1174 0.00133 0.00095
0.00092 0.00080 0.00057 -0.00024 -0.00025 12 0 2 0 21.1

Data field description:

- Date (yyyy/MM/dd): date.
- Time (hh:mm:ss): time.
- Timebase: timebase – units in seconds.
- Ref1, Sen1Ch1, Sen2Ch1...: are the raw signal Reference (Ref), Sensing Spot 1 (Sen1) and Sensing Spot 2 (Sen2) values from which the BC concentrations are calculated for channel 1 (Ch1), wavelength 370 nm. BC11 is the uncompensated BC calculated from the spot 1 for channel 1. BC1 is the final result for the BC calculated from measurements for channel 1 (370 nm). This is repeated for channels 2 through 7 (wavelengths 470 ~ 950 nm).
- Flow1; Flow2; FlowC: Measured flow in ml/min. Flow is flow through the spot 1, FlowC is common (total flow) through the optical chamber, Flow2 is the difference between these two.
- Pressure (Pa); Temperature (°C): These are the pressure and temperature which the instrument uses to report flow. By choosing to report mass flow, the values of (101325 Pa, 21.11 C) are used to convert the measured mass flow to reported volumetric flow at these conditions, since these are values used by the flow sensors in the AE33. These values can be exchanged for any other (Pressure, Temperature) values, if data reporting to other standards is required. Optionally, you can choose the data to be reported as volumetric flow at ambient conditions. In such a case, accessory measurements of the ambient (Pressure, Temperature) are required. We offer the 'AMES' meteorological sensor to provide this data automatically when connected to a COM port.
- BB (%): the percentage of BC created by biomass burning, determined by the Sandradewi model.
- ContTemp; SupplyTemp: control and power supply board temperatures
- Status; ContStatus; DetectStatus; LedStatus; ValveStatus; LedTemp: internal status codes for the instrument.
- BC11; BC12; BC1; BC21; BC22; BC2; BC31; BC32; BC3; BC41; BC42; BC4; BC51; BC52; BC5; BC61; BC62; BC6; BC71; BC72; BC7: BCn1 is the uncompensated BC calculated from the spot 1 for channel n; BCn2 is the uncompensated BC calculated from the spot 2 for channel n. BCn is the final result for the compensated BC calculated from measurements for channel n.

- K1; K2; K3; K4; K5; K6; K7: the K_n are the compensation parameters for wavelength channels n = 1 ~ 7

- TapeAdvCount: TapeAdvCount – tape advances since start

- ID_com1; ID_com2; ID_com3; The Fields_i: ID_com_i are the identifiers indicating which auxiliary device is connected to which serial port (necessary because of the different data structure). This is a 3 byte field: thus,

0 2 0 21.1

means that the “Comet temperature probe” (instrument code 2) is connected to COM2 and nothing is connected to COM1 and COM3. The temperature is 21.1 C.

If an additional auxiliary was connected to COM1, the dataline would be (ID_com1: 1 2 0):

Date(yyyy/MM/dd); Time(hh:mm:ss); Timebase; RefCh1; Sen1Ch1; Sen2Ch1; RefCh2; Sen1Ch2; Sen2Ch2; RefCh3; Sen1Ch3; Sen2Ch3; RefCh4; Sen1Ch4; Sen2Ch4; RefCh5; Sen1Ch5; Sen2Ch5; RefCh6; Sen1Ch6; Sen2Ch6; RefCh7; Sen1Ch7; Sen2Ch7; Flow1; Flow2; FlowC; Pressure (Pa); Temperature (°C); BB (%); ContTemp; SupplyTemp; Status; ContStatus; DetectStatus; LedStatus; ValveStatus; LedTemp; BC11; BC12; BC1; BC21; BC22; BC2; BC31; BC32; BC3; BC41; BC42; BC4; BC51; BC52; BC5; BC61; BC62; BC6; BC71; BC72; BC7; K1; K2; K3; K4; K5; K6; K7; TapeAdvCount; ID_com1; ID_com2; ID_com3; fields_i

2012/09/21 00:34:00 60 890416 524323 709193 823296 573862 756304 884844 619592
789142 822391 673266 816066 792706 686925 828401 738101 718325 841075 789053
722690 833686 3325 1674 4999 101325 21.11 -1 30 40 0 0 10 10 00000 0 1150 1290 1242
1166 1248 1215 1150 1231 1190 1146 1196 1175 1214 1195 1234 1144 1114 1139 1180
1225 1174 0.00133 0.00095 0.00092 0.00080 0.00057 -0.00024 -0.00025 12 1 2 0 20.0 45
1090 21.1

where the aux instrument with the code 1 is a weather station reporting temperature (20.0), RH (45%) and pressure (1090 mbar). the temperature 21.1 is reported by the “Comet temperature probe” installed at a different location.

11.2 System restore

This function allows all operational parameters of the Aethalometer to be restored from a previous setup file. Each time any parameter is changed, a new setup file is created and saved with the exact date and time. All previous setup files are always available as restore points. When “Sys. restore” button is pressed, the list of all previously backed up setup files is shown. Select the desired setup file by the date and time, and its parameters will be restored to the instrument.

11.3 Basic settings

“Basic settings” is a list of instrument operational parameters that may be imported from an external USB memory drive. This can ensure standardized operation. The settings are imported from the file AE_SETUP.XML that is saved in the root directory of the external drive. The file format is the same as the instrument setup file.

Using this action it is possible to import all setting except Serial Number, Flow Sensor calibration parameters, Tape Sensor calibration parameters, and External device settings. During the import process the setting are first validated: if the validation is successful, the settings from the file are written to the instrument and saved when the user starts measurement operations.

11.4 BC source apportionment

Source apportionment of black carbon emissions is based on the Sandradewi et al. (2008) model, with optical absorption coefficient being a sum of biomass burning and fossil fuel burning fractions. Model is based on the difference in absorption coefficient wavelength dependency assuming that absorption due to from fossil fuel and biomass emissions follow λ^{-1} and λ^{-2} spectral dependencies, respectively (Sandradewi 2008). The exponents which describe the spectral dependence are called Ångström exponents: $\alpha_{ff}=1$ for fossil fuel and $\alpha_{bb}=2$ for biomass. We get the following equations:

$$\frac{b_{abs}(470\text{ nm})_{ff}}{b_{abs}(950\text{ nm})_{ff}} = \left(\frac{470}{950}\right)^{-\alpha_{ff}} ,$$
$$\frac{b_{abs}(470\text{ nm})_{bb}}{b_{abs}(950\text{ nm})_{bb}} = \left(\frac{470}{950}\right)^{-\alpha_{bb}} ,$$
$$b_{abs}(470\text{ nm}) = b_{abs}(470\text{ nm})_{ff} + b_{abs}(470\text{ nm})_{bb} ,$$
$$b_{abs}(950\text{ nm}) = b_{abs}(950\text{ nm})_{ff} + b_{abs}(950\text{ nm})_{bb} ,$$

where $b_{abs}(\lambda)$ is absorption coefficient, λ is wavelength, $b_{abs}(\lambda)_{ff}$ a fossil fuel fraction and $b_{abs}(\lambda)_{bb}$ a biomass burning fraction of absorption coefficient. Portion of biomass burning BB(%) is:

$$BB(\%) = \frac{b_{abs}(950\text{ nm})_{bb}}{b_{abs}(950\text{ nm})} .$$

Biomass burning and traffic BC fractions are then calculated as:

$$BC_{bb} = BB * BC ,$$
$$BC_{ff} = (1 - BB) * BC .$$

Settings

- display of BB on the home screen is enabled by selecting Home display/procBB setting on Operation/Advanced tab.
- the algorithm can be fine-tuned by changing the value of Ångström exponents α_{ff} and α_{bb} , from the default values of $\alpha_{ff}=1$ and $\alpha_{bb}=2$.
- The calculated values are limited to the 0-100% range

Presentation

- BC and portion of biomass burning (%) are displayed on the Home tab.
- The percentage of BC created by biomass burning is stored in data file - column BB (%).

Reference

Sandradewi, J. et al. (2008), Using Aerosol Light Absorption Measurements for the Quantitative Determination of Wood Burning and Traffic Emission Contributions to Particulate Matter, Environ. Sci. Technol. 42, 3316–3323.

CHAPTER
SOFTWARE UPGRADE

12. SOFTWARE UPGRADE

1. Use only a high quality USB memory drive. Copy the following files to the root directory:
 - NK.bin - application software (SW version number not shown)
 - ae33coNNN.hex, ae33deNNN.hex, ae33leNNN.hex - three firmware files for version NNN.
2. Switch on the AE33: from the "Operation/General" screen, stop the measurements.
3. Insert the USB drive into the front panel. Wait 10 seconds.
4. On the "Operation/Advanced" screen, press the "Update" button.
5. Choose "Software" upgrade.
6. Wait until the Aethalometer finishes the upgrade.
7. Remove the USB drive.
8. Re-start the Aethalometer measurements, then stop again.
9. Insert the USB drive into the front panel. Wait 10 seconds.
10. On the "Operation/Advanced" screen, press the "Update" button.
11. Choose "Firmware" upgrade.
12. Wait until the Aethalometer finishes the upgrade. This can take a few minutes.
13. Remove the USB drive.
14. Re-start the Aethalometer measurements, then stop again.
15. Check the "Operation/Advanced" screen to verify the displayed values of the software and firmware versions.

CHAPTER
TROUBLESHOOTING

13. TROUBLESHOOTING

13.1 Startup screen checks

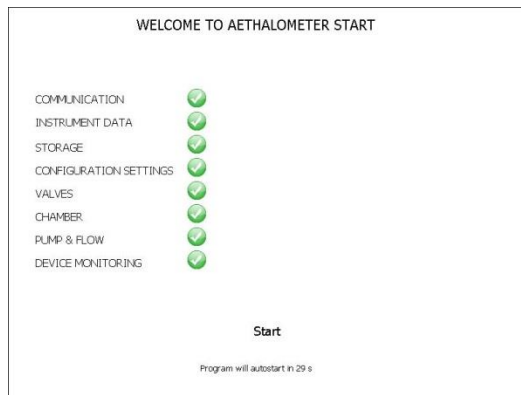

Check	Description	Error	Solution
Communication	communication PC to optical chamber controller	hardware problem	check cables
Instrument data	Obtain data (serial number) from the optical chamber controller	hardware problem	check cables
Storage	CF card operation	CF card error	get new CF card and SW
Configuration settings	read setting from the setup file	Setup file error	restore setup file from one of the older setup files
Valves	operation of the ball valve	ball valve not moving	check cables
Chamber	optical chamber movement test	locked chamber	unlock chamber
		hardware error	service needed
Pump & Flow	test if pump is working	pump	service needed
		tube connections	reconnect tubes
Device monitoring	Win CE operating system test	faulty application file	get new CF card and SW

13.2 Instrument status



Normal operation



Warning ; Instrument is still performing measurements, but there is/was an issue, that needs to be checked



Instrument stopped. Immediate response needed.

```

Instrument status:      3
Operation status:     3 - Stopped
Flow status:          0 - Flow OK
LED status:           0 - LEDs OK
Chamber status:       0 - Chamber OK
Filter tape status:   0 - Filter tape OK
Settings status:      0 - Settings OK
Tests status:         0 - No test
External device status: 0 - Connection OK
    
```

The instrument status code number and the colored icon are shown on the Home screen. Pressing the colored icon opens a screen with the status interpretation.

Status codes	Description	Problem	Solution
4,8,12	Flow status	flow not calibrated	calibrate flow (see section 9.3)
		clogged inlet line	check inlet lines, inlets
32, 48	LED status	Led calibration error	remove flow calibration pad
			update firmware
			faulty LED board -> service needed
64	Chamber status	Chamber locked	Unlock optical chamber
128, 256	Filter tape status	Not much filter tape remaining	Schedule filter tape replacement
384	Filter tape status	No filter remaining	Replace filter tape
		Filter not moving	Tighten right spool nut
8192	External device status	Connection with the external device not working	Check physical connection
			Check if correct COM port is used

13.3 Unacceptable quality control test results

Test	Criteria	Solution
Flow verification	Measured flows differ by more than 10 %	Calibrate flow
		Use good flow calibrator
		Verify use of correct flow reporting standard
Leakage test	$\zeta > 10 \%$	Lubricate optical chamber sliders
Stability test	PPBC61 > 450 ng/m	Clean the optical chamber
		Possible electronics problem
Clean air test	PPBC61 > 550 ng/m	Clean the optical chamber
		Check for air-conditioning effects

13.4 Other issues

Issue description	Possible cause	Solution
Reported flow <> set flow	flow not calibrated	calibrate flow
Overlapping spots on filter	tape sensors need adjustment or calibration	increase value of "TA adjust" parameter
		perform tape sensor calibration
		Clean filter tape optical sensors using dust-off spray of cotton swabs
Oscillations in BC data	Dirty optical chamber	Clean optical chamber
	Air conditioning effects	Install Sample Stream Dryer
Parameter k hit limit values	Air conditioning effects	Install Sample Stream Dryer
	Temperature change effects	Check installation temperature control
Software does not load – blank screen	Problem with CF card	Get a replacement CF card

CHAPTER
SPECIFICATIONS and ACCESORIES

14. SPECIFICATION

Operation:

- Supply voltage: 100-240 V~, 50/60 Hz
- Max power consumption: 90 W. Typical power consumption: 25 W
- Measurement wavelengths: 370, 470, 520, 590, 660, 880 and 950 nm
- Air flow: adjustable 2, 3, 4 and 5 LPM

Environmental operating conditions:

- Indoor use
- Altitude: up to 3000 m with internal pump, other configurations on request
- Temperature range: 10 – 40 degrees Celsius (instrument)
- Relative humidity range: non-condensing

Mechanical specification:

- Chassis material: sheet metal
- Front plate material: plastic
- Dimensions: standard 19"/6U, rack mount
- Weight: approx. 20 kg

Connectors:

- Sampling air: inlet / outlet type – ¼" NTPF
- Communication: 3x USB type A, 3x COM, 1x Ethernet

User interface:

- 8.4" SVGA display with LED backlight
- Basic control: touch-screen
- Optional control: standard PC keyboard and mouse
- Red, Yellow, Green status LEDs

15. ACCESSORIES

PRODUCT NO	DESCRIPTION	PHOTO
M8050	Filter Tape Roll, 10 m (1000 spots)	
M8072	Cartridge Filter	
M5510	Ambient Meteorological Sensor (P, T, RH): 10 m cable included	
AE5513	Extended cable for the AE33-MET2 with connectors, 20m	
M4121	MiniPM InletKit (includes PM10, PM4, PM2.5, PM1 and TSP)	
M4110	Sharp-Cut Cyclone Inlet, 2.5 µm cut at 5 LPM flowrate	

M4114 Sharp-Cut Cyclone Inlet, 2.5 μm cut at 2 LPM flowrate or 1 μm cut at 5 LPM flowrate



M4112 Sharp-Cut Cyclone Inlet, 1 μm cut at 2 LPM flowrate



M9610 Transit Case for shipping and field use, shockproof and waterproof



M9555 Insect and Water Trap



M5710 CO2 Sensor (Vaisala GMP343)



M5714 CO2 Sensor (Vaisala GMP343) communication cable



M5712 CO2 Sensor (Vaisala GMP343) power adapter



M5610 Sample Airstream Dryer - Nafion
Membrane (including external pump)



AE33-CPI Shipping carton box with protective foam
inserts



M7900 TSI 4140 Flow Meter (0.05-20 LPM)



M7950 BGI TetraCal (0.1 - 30 LPM)



M7662 Neutral Density Optical Filter Validation
kit



M3410 Tape Sensor Calibration Disc kit



CHAPTER
DRAWINGS

16. DRAWINGS

Front view

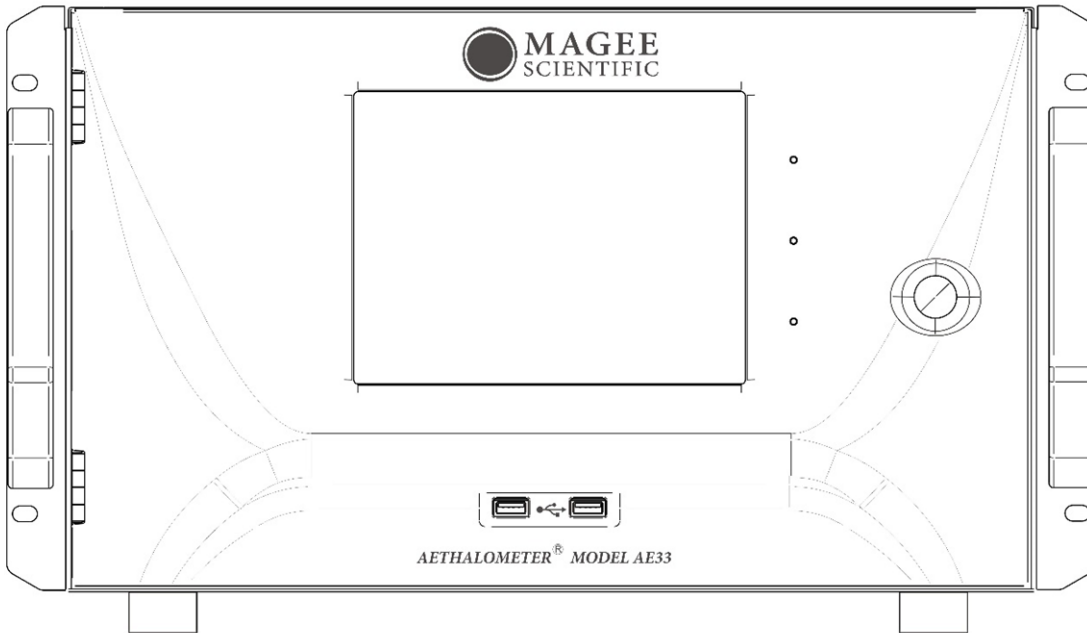

Front view, open door

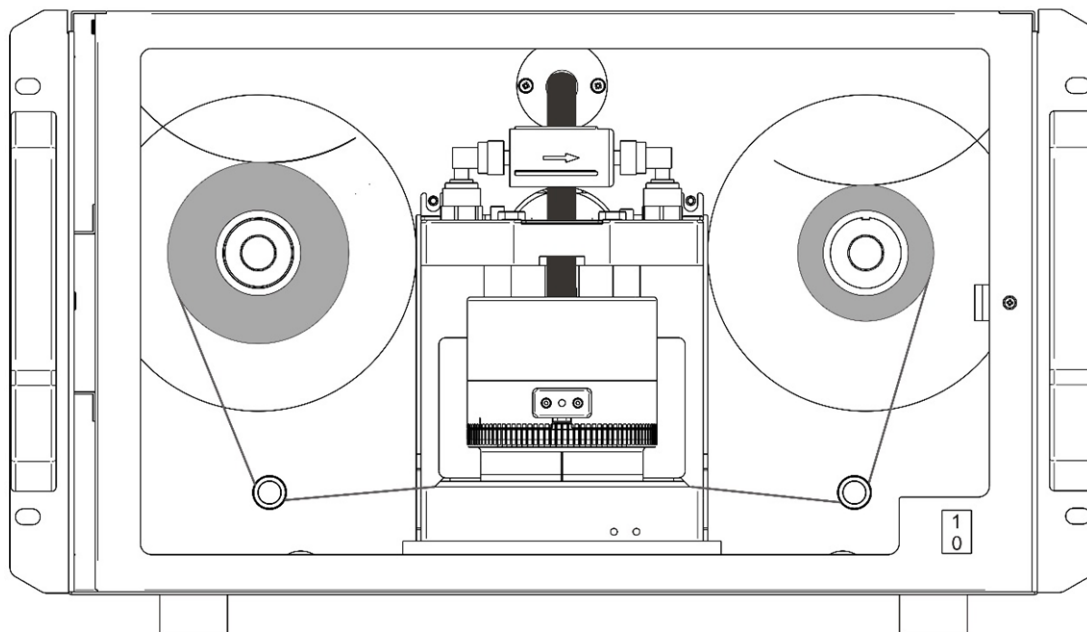

Rear view

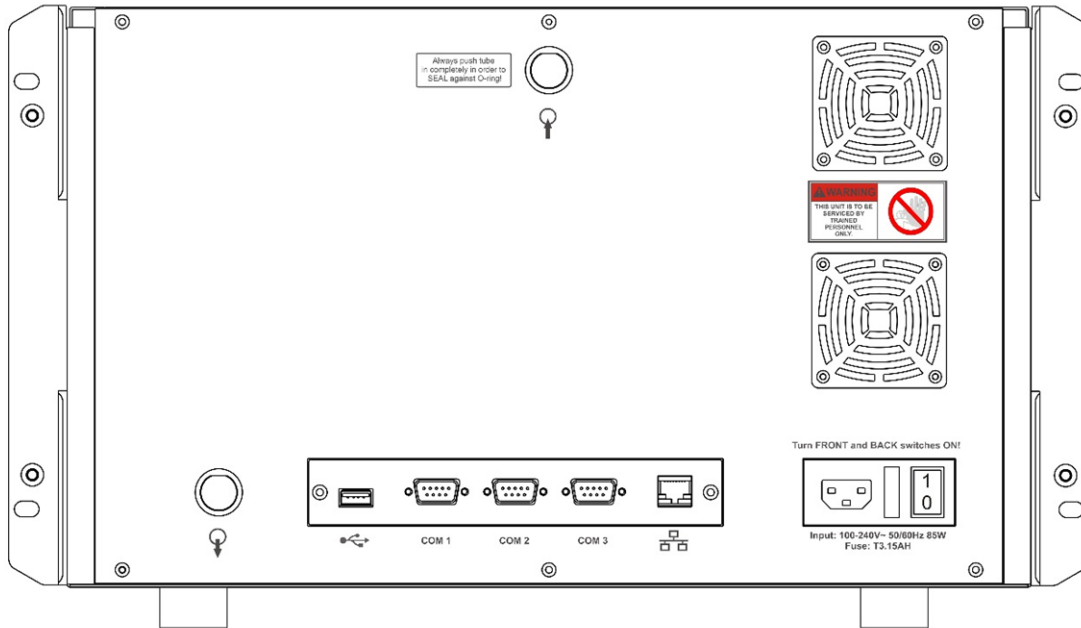

Rear view, no cover

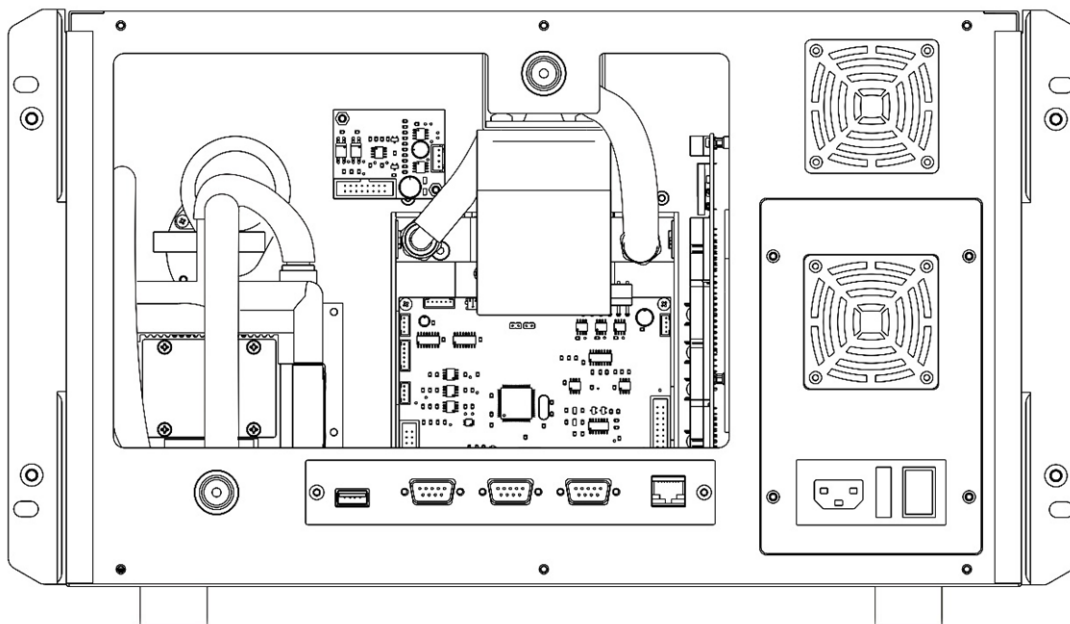

Exploded view

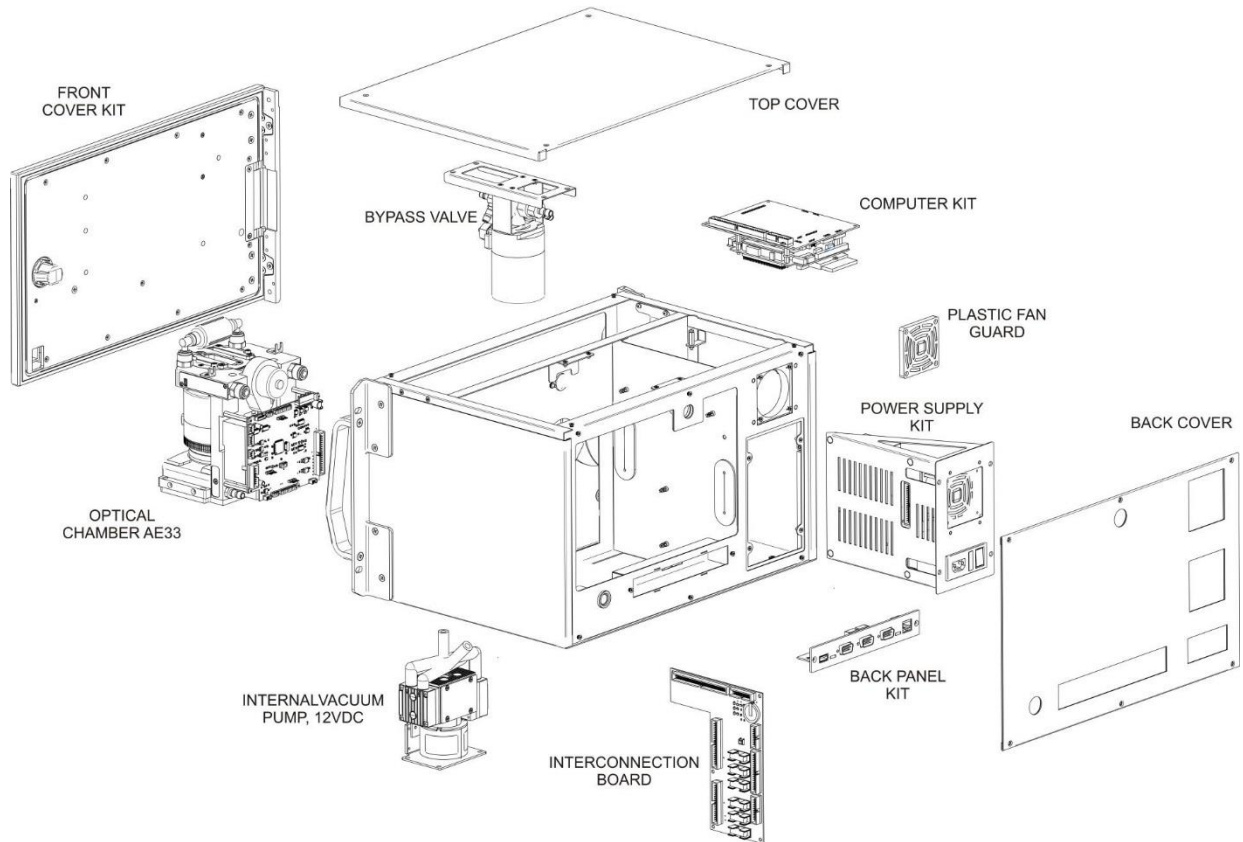

CHAPTER
THEORY OF OPERATION

17. THEORY OF OPERATION

The Aethalometer Model AE33 has been developed with input from the research and monitoring communities, and is designed for reliable operation under all conditions ranging from state-of-the-art research to compliance monitoring.

The leading innovations incorporated into the Model AE33 include:

1. The DualSpot™ measurement method, which solves the effects common to all filter-based real-time monitors, in which the instrumental response factor shows a dependence on the loading of material on the filter.
2. Features for automatic ‘dynamic zero’ testing under a flow of internally-generated clean air; ‘span’ testing of the response of the optical sources and detectors; calibration of the response of the internal mass flow meters, if an external standard flow calibrator is connected; and validation of the photometric response by use of a kit of ‘Neutral Density’ optical filters whose properties may be traced to reference standards.
3. User and communications interfaces, permitting remote monitoring of operation; data retrieval; performance of internal tests; and reporting of ‘state-of-health’ parameters.
4. Modular construction designed for ease of routine maintenance service.

In addition to the above features, the Aethalometer Model AE33 offers real-time aerosol absorption analysis at up to ten optical wavelengths, with rapid time resolution to 1 second even in 7-wavelength mode. This permits the measurement of optically-absorbing aerosols – ‘Black’ Carbon and ‘Brown’ Carbon components of particulate matter – in applications including routine monitoring of ambient air quality for regulatory purposes; measurements of the

concentration of BC in urban, suburban, regional, rural and remote locations; source testing; and laboratory-based research.

‘DualSpot™’ technology

The Aethalometer Model AE33 uses the patented DualSpot™ method to compensate for the ‘spot loading effect’; and also to provide a real-time output of the ‘loading compensation’ parameter, which may provide additional information about the physical and chemical properties of the aerosol.

The ‘spot loading effect’ is a variable phenomenon which appears as a gradual reduction of instrumental response as the aerosol deposit density of the filter tape increases from zero to the predetermined limit of ‘Maximum Attenuation’ (Gundel 1984, Weingartner 2003, Arnott 2005, Virkkula 2007, Kanaya 2008, Hyvärinen 2012). When the filter tape advances to a fresh spot, the data undergoes a discontinuous jump from its previous lower value, calculated when the spot was heavily loaded; to a higher value, calculated from collection on a fresh spot at zero loading. In the Aethalometer the reduction of data at increasing loadings is well described by a linear function of attenuation, but its magnitude cannot be predicted: some aerosols in some locations in some seasons may show a small or zero ‘loading effect’; while under other conditions, the effect may be larger and noticeable. Empirically, it is found that fresher aerosols closer to their combustion sources will show a larger ‘spot loading effect’; while well-aged aerosols under atmospheric conditions of high chemical activity and oxidative processing may show an almost zero effect. The effect is revealed statistically by processing data collected over a large number of tape advances, representing many data points collected at loadings (‘ATN values’) ranging from zero to the preset maximum. The data is collected into bins according to loading (attenuation, ATN). If there is a systematic reduction of the calculated result as a function of loading, the data will show a clear negative slope, with the intercept representing the ‘zero loading’ value. Figure 7 illustrates two datasets from urban locations with loading effects either present or not.

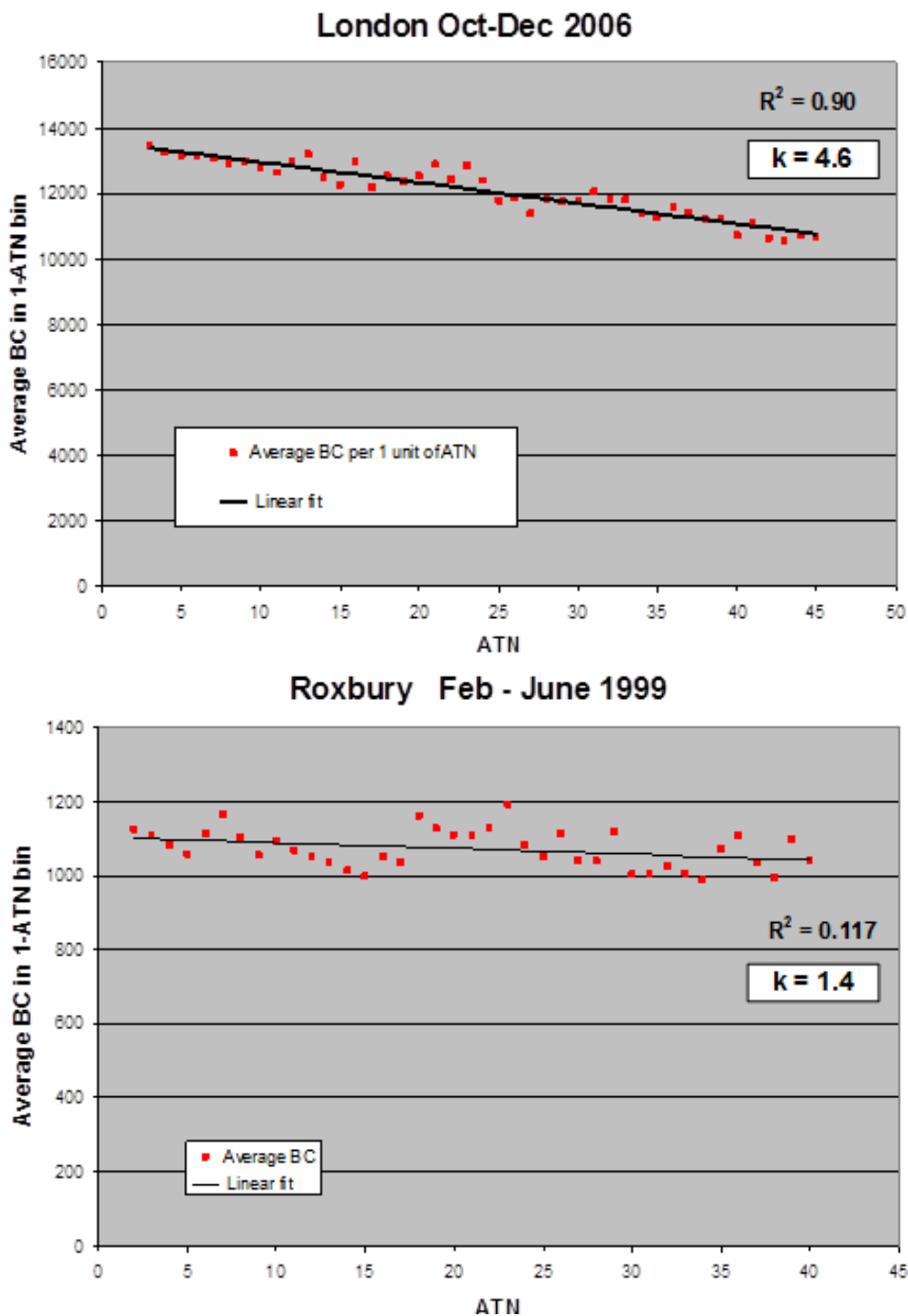

Figure 7. Aethalometer data sorted and averaged according to loading (attenuation, ATN) on spot - roadside location in London, UK (top); urban site in Boston (Roxbury), USA (bottom).

The London data show a systematic reduction at increasing loadings; while the Boston data do not. This demonstrates that any method intended to compensate for the ‘spot loading effect’ must be auto-adaptive and able to adjust dynamically to different situations. An instrument based on firmware with a fixed ‘loading non-linearity’ parameter will not operate correctly at all locations. The ‘loading non-linearity’ parameter must be measured.

It is clear that the effect, when present, is linear with loading (‘ATN’). This can be represented as

$$BC \text{ (reported)} = BC \text{ (zero loading)} * \{ 1 - k \cdot ATN \}$$

where BC (zero loading) is the desired ambient BC value that would be obtained in the absence of any loading effect; and k is the ‘loading compensation parameter’ (similar to Virkkula, 2007).

The analysis of a large number of datasets from a wide variety of locations shows that this relationship is linear in all cases studied; but with different values of k. It is therefore possible to eliminate the ‘loading effect’ of k by making two simultaneous identical measurements BC1 and BC2 at different degrees of loading ATN1 and ATN2.

$$BC1 = BC * \{ 1 - k \cdot ATN1 \}$$

$$BC2 = BC * \{ 1 - k \cdot ATN2 \}$$

From these two linear equations we may calculate the ‘loading compensation parameter’ k; and the desired value of BC compensated back to zero loading.

The Aethalometer Model AE33 analyzes the Black Carbon component of aerosols on two parallel spots drawn from the same input stream, but collected at different rates of accumulation, i.e. at different values of ATN. By combining the data according to the above equations, the AE33 yields the value of BC extrapolated back to ‘zero

loading'; as well as a real-time output of the 'loading compensation parameter' k which provides insights into the aerosol nature and composition. This process is performed in real time for all wavelengths: examination of the ' k ' values as a function of wavelength provides further information about the aerosol composition. An example of this is shown for extreme concentrations of black carbon (Figure 8).

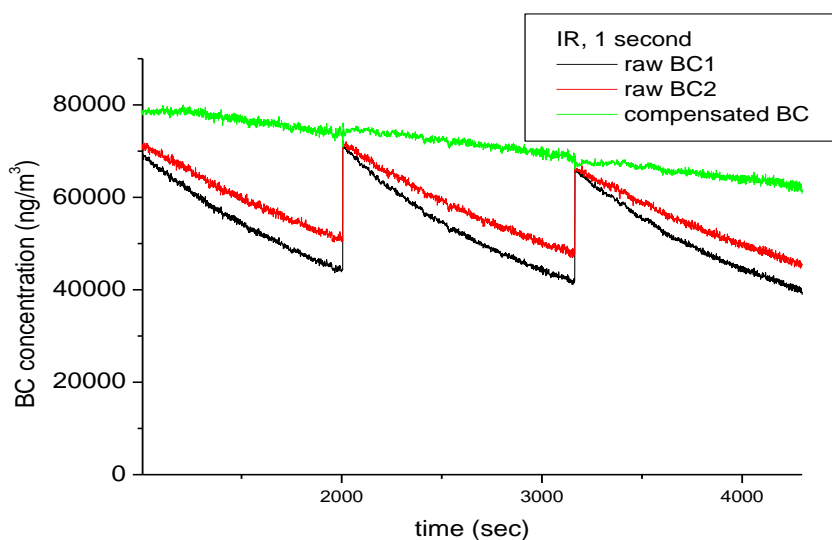

Figure 8. The time-series of AE33 raw and compensated BC concentrations with 1 second timebase - note the extreme concentrations and loading effects.

Automatic Zero and Span

The Aethalometer Model AE33 offers the capability for automatically checking the ‘zero-air’ response of the instrument under dynamical operating conditions. This test is implemented by back-flushing the inlet connection with an excess flow of internally-filtered air and circulating the filtered air in the instrument. The data reported during this period are analyzed for the mean value and the point-to-point variation. The mean value should be close to zero under ideal conditions; any positive value greater than zero represents the leakage of BC-containing room air into the instrument’s analytical zone. The point-to-point variation represents the instrument’s measurement noise level under actual operating conditions of actual flow – i.e., a ‘dynamic’ test. The point-to-point variation for the wavelength 880 nm at the time-base set to one second is about 350 ng/m³, which translates to a few ng/m³ at 1-minute time resolution (Figure 9).

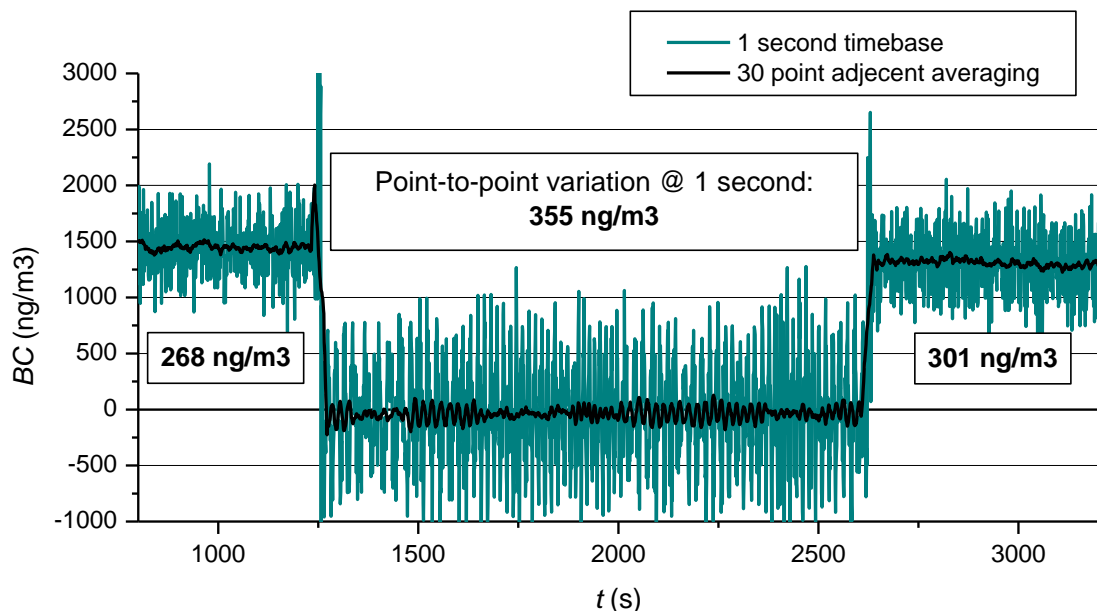

Figure 9. ‘Zero-air’ check – the Aethalometer Model AE33 switches form sampling ambient air to filtered air – 1 second time resolution point-to-point variation is very stable.

The response of the optical detectors of the Aethalometer Model AE33 may be verified by use of a standard kit of Neutral Density optical filters. These are glass elements with a range of known and stable optical absorptions, from light to dark, which are traceable from manufacturing records back to primary standards. When these are inserted into the AE33 Aethalometer, its photodetectors will give a certain output signal. The stability and reproducibility of the relationship between optical signal and ND Filter density from one validation test to another; and the comparison with the original factory values; is a measure of the consistency of performance of the instrument's optics.

User and Communications Interfaces

The Aethalometer Model AE33 incorporates the following user, data and communications features:

- 21-cm color graphics touch-screen for data display and local user interface;
- USB ports for insertion of a memory stick for local data download;
- USB ports for connection of a keyboard, if necessary for initial setup of parameters, such as station identification;
- RS-232 COM ports for data transmission from auxiliary instruments or to the digital datalogger;
- Ethernet port for full network access and control, including
 - i. Remote data acquisition, either batch or streaming
 - ii. Remote retrieval of instrument status and state-of-health
 - iii. Remote control of instrument operating parameters

Modular Construction

The Aethalometer Model AE33 is constructed with a modular design, so that sub-units may be easily serviced. The only item requiring attention in routine use is cleaning of the optical insert to remove accumulated dust or other contamination which may be brought in with the sample air stream. The optical chamber is attached with a bayonet fitting for quick removal; easy

cleaning; and reliable re-assembly. The entire instrument is hermetically sealed to reduce the entry of dust.

References

- Arnott, W. et al. (2005), Towards Aerosol Light-Absorption Measurements with a 7-Wavelength Aethalometer: Evaluation with a Photoacoustic Instrument and 3-Wavelength Nephelometer *Aerosol Sci. Technol.*, 39, 17-29.
- Gundel, L.A., et al. (1984), The Relationship Between Optical Attenuation and Black Carbon concentration for Ambient and Source Particles, *Sci. Total Environment*, 36, 197-202.
- Hyvärinen A.-P. et al. (2013), Correction for a measurement artifact of the Multi-Angle Absorption Photometer (MAAP) at high black carbon mass concentration levels, *Atmos. Meas. Tech.*, 6, 81-90.
- Kanaya et al. (2008), Mass concentrations of black carbon measured by four instruments in the middle of Central East China in June 2006, *Atmos. Chem. Phys.*, 8, 7637–7649.
- Virkkula A. et al. (2007), A Simple Procedure for Correcting Loading Effects of Aethalometer Data, *J. Air & Waste Manage. Assoc.*, 57, 1214–1222.
- Weingartner, E., et al. (2003), Absorption of Light by Soot Particles: Determination of the Absorption Coefficient by Means of Aethalometers *J. Aerosol Sci.*, 34, 1445-1463.

CHAPTER
CONFORMITY DOCUMENTS

18. CONFORMITY DOCUMENTS

CE DECLARATION OF CONFORMITY

The undersigned authorized manufacturer,

AEROSOL d.o.o.
Karniška 41
SI-1000 Ljubljana
SLOVENIA

web: www.aerosol.si
tel: +386 59 191 220
fax: +386 59 191 221

herewith declare that the product: **Aethalometer, AE33-x; where "x" is any number between 1 and 10**
with the characteristics specified in the Technical Construction File **AE33-TCF2012**, 21 September 2012,

to which this declaration relates is in conformity with the provisions of the following EC Directives when used in accordance with the instructions contained in the product documentation:

2004/108/EC	Electromagnetic Compatibility (EMC)
2006/95/EC	Low Voltage Equipment (LVD)

and complies with the provisions of the following European, harmonized and published standards at the date of this declaration:

EMC:	EN 61326-1:2006 EN 61000-3-2:2006+A1:2009+A2:2009 EN 61000-3-3:2008
-------------	---

LVD:	EN 61010-1:2010
-------------	-----------------

Test reports issued by:	SIQ, Tržnška cesta 2, SI-1000 Ljubljana, SLOVENIA
-------------------------	---

Report ref. No:	1223-0301/ 2 (LVD) 1251-0333/ 2 (EMC)
-----------------	--

Year in which CE mark was affixed: **2012**.

Name:	Griša Močnik, PhD
Position:	Director, Aerosol d.o.o.

Signature:



Place and date:	Ljubljana, 21 September 2012
-----------------	------------------------------



Aerosol
Karniška 41, SI-1000 Ljubljana, Slovenia

CHAPTER
CUSTOMER SERVICE AND SUPPORT

19. CUSTOMER SERVICE

Please contact the service department through our web sites (Service & Support):

www.mageescientific.com or

www.aerosol.eu

Please include the serial number of the instrument and a sample of recent data in the communication. Always send the raw files (data, log and setup).

Aerosol d.o.o.

Kamniška 41

SI-1000 Ljubljana

SLOVENIA

EUROPE

fax: +386 59 191 221

www.aerosol.eu

In the US, please contact:

Magee Scientific Corporation

1916A M.L. King Jr. Way

Berkeley CA 94704, USA

fax: +1 510 845 7137

www.magescientific.com

The distributor responsible for your country is:

--

20. RETURNS FOR SERVICE

Before returning any Magee Scientific instrument to service, please contact either Magee Scientific or Aerosol office.

Aerosol d.o.o., Kamniška 41, SI 1000 Ljubljana, Slovenia.

tel: +386 1 4391 700

support@aerosol.eu

Magee Scientific Corporation, 1916A M.L. King Jr. Way, Berkeley CA 94704, USA

tel: +1 510.845.2801

support@magescientific.com

Before sending an email or making a phone call, please prepare the following information:

- **Instrument serial number**
- **Purchase order number**
- **Service report (if available)**
- **Shipping/billing address**
- **Responsible person**

When shipping the instrument, please use original packing material (cardboard box with foam inserts).

